

**DVI, DISPLAY PORT, HDMI INTERFACE CONTROLLER
FOR TFT PANEL**

Model: SVX-4096-VW

Part number : 41762001X-3 or up

INSTRUCTIONS

CONTENTS

Page: **2. Introduction, How to Proceed, Usage Note, Disclaimer**
3. System design – Diagram of a suggested system
5. Assembly notes – Important information about system elements
7. Connection & Operation – How to use the controller
13. Connectors, pinouts & jumpers – Essential connection information
27. Controller dimensions
28. Application notes
30. Troubleshooting
31. Specifications
32. Appendix I – Network connection
33. Appendix II – RS-232 control protocols and command set
44. Appendix III - Mapping definition
46. Appendix IV – DV remote control unit work for SVX-4096-VW
47. Appendix V – Functions list on browser page
50. Warranty, Caution & Limitation of Liability, Trademarks
51. Contact details
52. Revision History

It is essential that these instructions are read and understood before connecting or powering up this controller.

Introduction

Designed for LCD monitor and other flat panel display applications, the SVX-4096-VW is a feature rich interface controller for :

- TFT (active matrix) LCD panels of 4096x2160 resolutions in 60Hz with V-by-One interface.
- TFT (active matrix) LCD panels of 1920x1080 resolution in 60Hz with LVDS interface.
- Support true 10 bits panel.
- Support HDMI, DVI and Display Port input.

HOW TO PROCEED

- Ensure you have all parts & that they are correct, refer to:
 - Connection diagram

Controller Solution Generator

Full web resource matching controllers & panels with **connection diagrams** for download.
See at : <http://www.digitalview.com/csg>

- Connector reference (in following section)
- Assembly notes
- Check controller switch & jumper settings (errors may damage the panel)
- Prepare the signal sources
- Connect the parts
- Understand the operation & functions

IMPORTANT USAGE NOTE

This equipment is for use by developers and integrators, the manufacturer accepts no liability for damage or injury caused by the use of this product. It is the responsibility of the developer, integrators or other user of this product to:

- Ensure that all necessary and appropriate safety measures are taken.
- Obtain suitable regulatory approvals as may be required.
- **Check power settings to all component parts before connection.**

DISCLAIMER

There is no implied or expressed warranty regarding this material.

SYSTEM DESIGN

A typical LCD based display system utilizing this controller is likely to comprise the following:

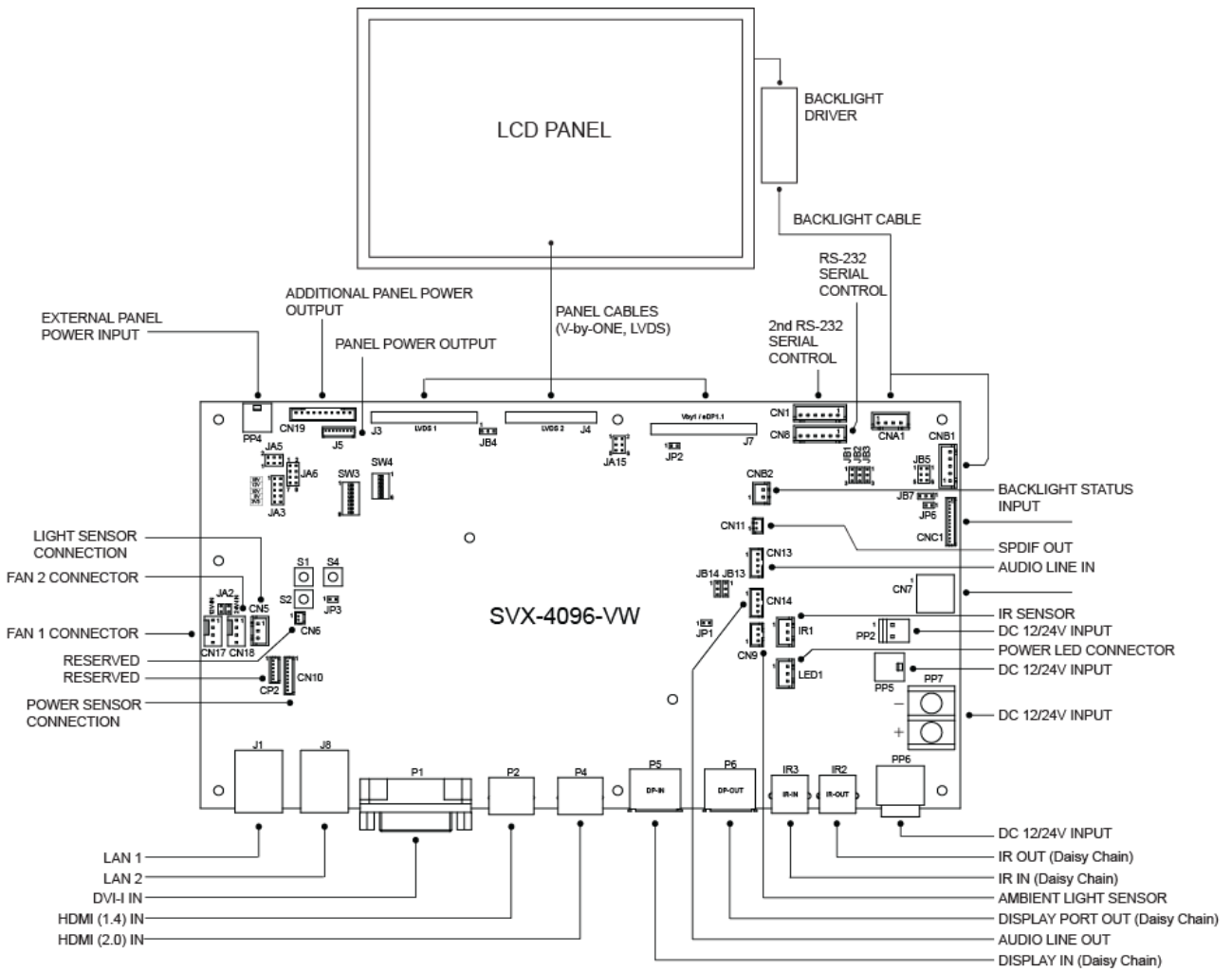

Daisy Chain connection diagram:

To use more SVX-4096-VW connected to each other, connect one end of the signal input cable (DP cable, LAN cable and IR cable) to the 'OUT' connector of SVX-4096-VW board and connect the other end to the 'IN' connector of next SVX-4096-VW board.

Video input source

Daisy-chain on SVX-4096-VW

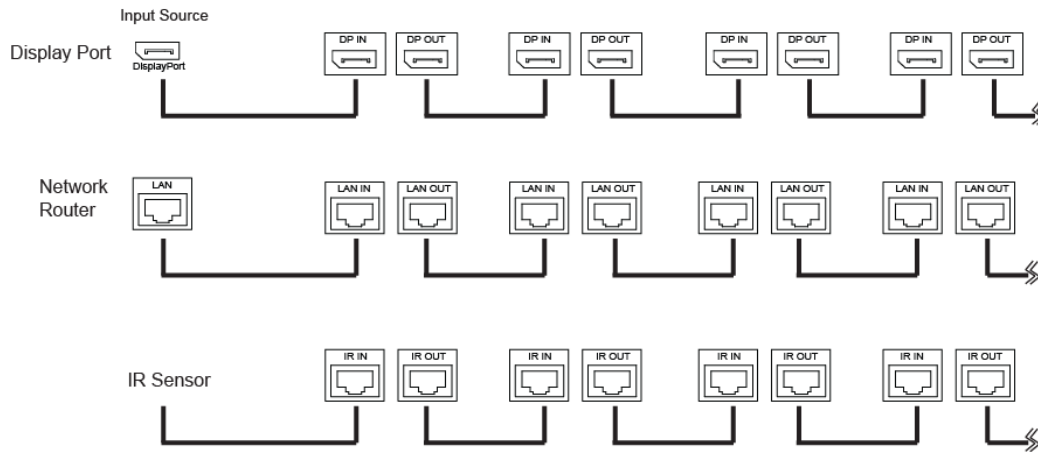

ASSEMBLY NOTES

This controller is designed for monitor and custom display projects using 4096x2160 resolution with V-by-One interface or LVDS TFT panels. The following provides some guidelines for installation and preparation of a finished display solution.

Preparation: Before proceeding it is important to familiarize yourself with the parts making up the system and the various connectors, mounting holes and general layout of the controller. As much as possible connectors have been labeled. Guides to connectors and mounting holes are shown in the following relevant sections.

- 1. LCD Panel:** This controller is designed for typical V-by-One (8 lanes) and LVDS interfaced panels with panel voltage 3.3V(4A), 5V(4A), 10V(4A), 12V(4A) or 18V(3A), External for 10V, 12V and 18V interface. Due to the variation between manufacturers of panels signal timing and other panel characteristics, factory setup and confirmation should be obtained before connecting to a panel. **(NOTE: Check panel power jumper settings before connection)**
- 2. LCD Controller:** Handle the controller with care as static charge may damage electronic components. Make sure correct jumper to match the target LCD panel.
- 3. Panel cable:** In order to provide a clean signal it is recommended that all panel cables (V-by-One signal and LVDS) supplied by Digital View. Care should be taken when placing the cables to avoid signal interference.
- 4. Inverter/Backlight driver:** This will be required for the backlight of an LCD, some LCD panels have an inverter/backlight driver built in. As LCD panels may have 1 or more backlight tubes and the power requirements for different panel backlights may vary it is important to match the inverter/backlight driver in order to obtain optimum performance. See Application notes page 27 for more information on connection.
- 5. Inverter/backlight cables:** Different inverter/backlight models require different cables and different pin assignment. Make sure correct cable pin out to match the inverter/backlight. Using wrong cable pin out may damage the inverter/backlight.
- 6. Function Controls:** The following section discusses the controls required and the section on connectors provides the detail. The controls are minimal: On/Off, Backlight Brightness (depends on inverter), OSD (5 momentary buttons) analog VR type or (8 momentary buttons) digital type.
- 7. Function controls cable:** The cables to the function switches should be of suitable quality and length so that impedance does not affect performance. Generally lengths up to 1 meter (3 feet) should be acceptable.
- 8. Optional LED:** The pin direction of the LED should be corrected for right color indication. Red color stands for standby. Green colors stands for signal on. The status LED is an optional part only, can be unconnected.
- 9. Optional IR sensor:** It is an optional part only, can be unconnected if not using IR remote control.
- 10. RS-232 control interface :** Serial control via this interface port.
- 11. External panel power output :** User for specific panel model.
- 12. Panel control signal :** Use for specific panel model.
- 13. SPDIF Audio output :** This port support SPDIF audio output from the HDMI / Display Port audio source inputted.
- 14. Ambient light sensor connection :** 3 ways connector provides interface for ambient light sensor connection by using Kit 70220-3.
- 15. Backlight status input :** 2 ways connector provides interface for connection with the specific panel type which support the panel with backlight status monitoring function.
- 16. DVI-I input cable :** Plug the DVI cable to the connector P1 on the controller board.
- 17. HDMI input :** Plug the HDMI cable to the connector P2(HDMI 1.4) / P4(HDMI 2.0) on the controller board.
- 18. Control over network connection :** This is a network device that allow to control RS-232 enable devices over a TCP/IP based Ethernet and the Internet using a web browser. Please refer to Appendix V in details.
- 19. Reserved for Audio adaptor board P/N 416940020-3:** The audio add-on board gives the audio input and output signal connection. It is an optional and reserved part only, can be unconnected if not using audio. It requires an audio cable P/N 426451800-3 to connect SVX-4096-VW (CN14) to the Audio Add-on Board (CN2).
CAUTION : The Audio Add-on Board P/N 416940020-3 can only operate with 12VDC power input environment.
- 20. Reserved for Audio extend cable :** The audio extend cable P/N 426009700-3 designs for connection between audio add on board P/N 416940020-3 and the controller. It is an optional and reserved part only, can be unconnected if not using audio.
- 21. Additional panel power input :** Provide additional (+10V/+12V/+18V) panel power input for driving high power consumption panels.

- 22. Power Input:** 12V/24VDC is required, this should be a regulated supply. The power rating is depending on the panel and inverter used. Normally, power supply with 3.5A current output should be enough for most of 4xCCFT panels. Although the controller provides power regulation for the LCD power this does not relate to the power supplied to the backlight inverter. If an unregulated power supply is provided to an inverter any fluctuations in power may affect operation, performance and lifetime of the inverter and or backlight tubes.
- 23. External panel power input :** Allow to supply external power to the panel separately for max 3.3V (7A) or 5V (7A) or 10V (5A) or 12V (5A) or 18V (3.5A) via PP4 power input connector. Corresponding jumper setting of JA3, JA5 & JA6 are required for each panel power input by referring to page 16.
- **Power output:** Note the controller has an overall 3Amp current limit and the current available from the auxiliary power output will be dependent on the power input and other system requirements.
 - **Power Safety:** Note that although only 12V / 24VDC is required as 'power-in' a backlight inverter for panel backlighting produces significantly higher voltages (the inverter does not connect to the ground plane). We strongly advise appropriate insulation for all circuitry.
 - **EMI:** Shielding will be required for passing certain regulatory emissions tests. Also the choice of external Controller to PC signal cable can affect the result.
 - **Ground:** The various PCB mounting holes are connected to the ground plane.
 - **Servicing:** The board is not user serviceable or repairable. Warranty does not cover user error in connecting up to the controller and is invalidated by unauthorized modification or repairs.
 - **Controller Mounting:** It is recommended that a clearance of at least 10mm is provided above and 5mm below the controller when mounted. Additionally consideration should be given to:
 - Electrical insulation.
 - Grounding.
 - EMI shielding.
 - Cable management. Note: It is important to keep panel signal cables apart from the inverter & backlight cables to prevent signal interference.
 - Heat & Ventilation: Heat generated from other sources, for example the backlight of a very high brightness panel may generate significant heat which could adversely affect the controller.
 - Other issues that may affect safety or performance.
 - **PC Graphics Output:** A few guidelines:
 - Signal quality is very important, if there is noise or instability in the PC graphics output this may result in visible noise on the display.
 - Refer to graphics modes table in specifications section for supported modes.
 - Non-interlaced & interlaced video input is acceptable.

IMPORTANT: Please read the Application Notes section for more information.

CONNECTION & OPERATION

CAUTION: Never connect or disconnect parts of the display system when the system is powered up as this may cause serious damage.

CONNECTION

Connection and usage is quite straight forward (it is useful to have the relevant connection diagram available at this time):

1. **LCD panel & Inverter:** Connect the inverter/Backlight driver (if it is not built-in the panel) to the inverter/backlight connector of the LCD panel.
2. **V-by-One interface panels:** The controller board supports V-by-One interface 4K panel. Plug the cable to J7 for driving 4K 60Hz panel. And make sure the matching panel timings and correct jumper settings (JA15) by referring to the panel support table and jumper settings table in page 13-18.
3. **LVDS interface panels:** The controller board supports LVDS interface panel. Plug the cable to J3/J4 for driving FHD 60Hz panel. And make sure the matching panel timings and correct jumper settings by referring to the panel support table and jumper settings table in page 13-18.
4. **Inverter/Backlight driver:** Plug the inverter/backlight cable to CNB1 and CNA1 (if necessary). Plug another end to the connector on the inverter/backlight of panel side.
5. **Function switch & Controller:** Plug the OSD switch mount cable to CNC1 on the controller board and another to the OSD switch mount.
6. **LED & Controller:** Plug in a 3-way with dual color LED to connector LED1 on the controller board.
7. **IR & Controller:** Plug in a 3-way with IR sensor to connector IR1 on the controller board. For IR daisy chain connection, use RJ-11 cable to connect all monitors with IR in and IR out connectors.
8. **Jumpers & Inverter & Panel voltage:** Particularly pay attention to the settings of JA3, JA5, JA6, JB2 and JB3. JB2 & JB3 are used for inverter control (read inverter specification and information on the jumper table to define the correct settings). JA3 & JA5 & JA6 is used for panel voltage input (read panel specification and information on the jumper table to define the correct settings).
9. **Input signal cable & Controller:** Plug the corresponding signal input to the connector on the controller board.
10. **Power supply & Controller:** Plug the DC 12V/24V power in to the connector PP2, PP5, PP6 and PP7. You can consider to use DigitalView mating power cable P/N 426013710-3, 1000mm for PP5 connection.
11. **External panel power input :** Plug power cable : P/N 426013710-3 for external panel power input (3.3 (max 7A) / 5V (max 7A) / 10V (max. 5A) / 12V (max 5A) / 18V (max3.5)) for PP4 connection.
12. **Power on:** Switch on the controller board and panel by using the OSD switch mount.

General:

- If you are using supplied cables & accessories, ensure they are correct for the model of panel and controller.
- If you are making your own cables & connectors refer carefully to both the panel & inverter specifications and the section in this manual, "Connectors, Pinouts & Jumpers" to ensure the correct pin to pin wiring.

PC SETTINGS

The controller has been designed to take a very wide range of input signals however to optimize the PC's graphics performance we recommend choosing 60Hz vertical refresh rate – this will not cause screen flicker.

OPERATION

Once the system has been connected and switched on there are a number of functions available to adjust the display image as summarized in the following sections. The settings chosen will be saved for each mode independently.

LCD DISPLAY SYSTEM SETTINGS

NOTE: By way of explanation the following refers to a set of sample buttons that may be obtained as an option. In addition to power on/off and connection for backlight brightness the controller provides an On Screen Display of certain functions which are controlled by 5 momentary type buttons (analog VR type) or 8 momentary type buttons (digital type):

Controls	Analog VR type	Digital type
On/Off – turns controller board power on	VR toggle switch	On/Off button
Brightness – controls backlight brightness	Rotary VR	Brightness +/- buttons
Menu • Turns OSD menu On or Off (it will auto time off)	Menu button	Menu button
Select up • Moves the selector to the previous level function (up)	SEL UP	SEL UP
Select down • Moves the selector to the next level function (down) • Confirm the OSD selection	SEL DN	SEL DN
+ • Increase the OSD parameter values • Moves the selector to next function (forward)	+	+
- • Decrease the OSD parameter values • Moves the selector to previous function (backward)	-	-

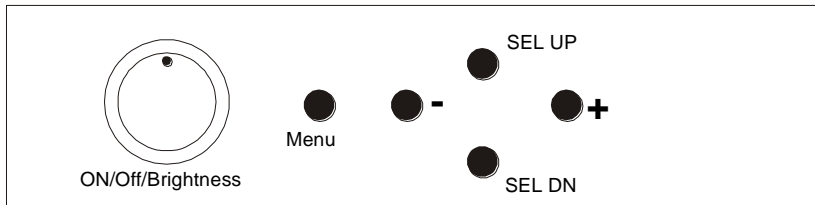

Analog VR type



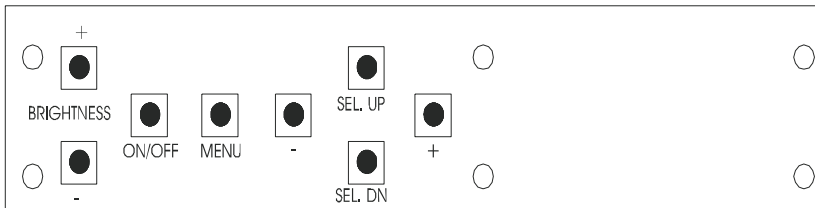







12V / 24VDC power input :
Analog 10K VR Type OSD switch mount uses P/N 410680550-3 or up







Digital type



12V / 24VDC power input :
Digital 10K Type OSD switch mount uses P/N 416100520-3 or up

OSD functions

 <p>Display Mode</p>	<p>Display Mode:</p> <div style="display: flex; justify-content: space-around; align-items: center;">      </div> <p>[Default]</p>
 <p>Display Function</p>	<p>Display Function:</p> <p>1P: Disp Rotate : 0 [Default] 90 180 270</p> <p>2P LR: Input Swap</p> <p>2P TB: Input Swap</p> <p>2P PIP: PIP Position : Top-left Top-right Bottom-left Bottom-right [Default]</p> <p>PIP Transparency : [0 - 10] [Default 0] PIP Size : [0 - 10] [Default 10] Input Swap</p>
 <p>Picture</p>	<p>Picture:</p> <p>Backlight [0-100] [Default 100] Brightness [0-100] [Default 50] Contrast [0-100] [Default 50] Sharpness [0-4] [Default 2]</p>
 <p>VGA Setup</p>	<p>VGA Setup:</p> <p>Auto Adjust H Position [0-100] [Default 50] V Position [0-100] [Default 50] Clock [0-100] [Default 50] Phase [0-100] [Default 0]</p> <p>Color Gain : Set Reset</p>
 <p>Color</p>	<p>Color:</p> <p>Gamma : 1.8 2.0 2.2 [Default] 2.4</p> <p>Temperature: 9300 7500 6500 [Default] 5800 3200 sRGB User : R [0-255] G [0-255] B [0-255]</p> <p>Color Effect: Standard [Default] Game Movie Photo Vivid</p>

	<p>User: R: Hue [0-100] Sat [0-100]</p> <p>Y: Hue [0-100] Sat [0-100]</p> <p>G: Hue [0-100] Sat [0-100]</p> <p>C: Hue [0-100] Sat [0-100]</p> <p>B: Hue [0-100] Sat [0-100]</p> <p>M: Hue [0-100] Sat [0-100]</p> <p>Hue: [0-100] [Default 50] Saturation [0-100] [Default 50]</p>
	<p>Advanced:</p> <p>Aspect Ratio: Full [Default] 16:9 4:3 5:4 1:1</p> <p>Over Scan: ON [Default] OFF</p> <p>Over Drive: ON/OFF: ON OFF [Default] OD Gain [0-100] [Default 50]</p> <p>Communication: RS-232 [Default] Network</p> <p>Auto Source Seek: OFF ON [Default]</p> <p>Hot Key: Hot Key 1 (< >) : Input Backlight Brightness Contrast Sharpness Hue Saturation Aspect Ratio Display Mode Input Swap PIP Size Auto Adjust Volume No Function [Default]</p> <p>Hot Key: Hot Key 1 (Up Dn) : Input Backlight Brightness Contrast Sharpness Hue Saturation Aspect Ratio Display Mode Input Swap PIP Size Auto Adjust Volume No Function [Default]</p>

	<p>Power Save: OFF ON [Default]</p> <p>Default Power: OFF ON [Default]</p>
 <p>Input</p>	<p>Input: (For all display modes: 1P/ 2R LR / 2P TB / 2P PIP / 4P)</p> <p>A0 : VGA D0 : DP D1 : HDMI D2 : HDMI D4 : DVI</p>
 <p>Audio</p>	<p>Audio:</p> <p>Volume [0-100] [Default 50]</p> <p>Mute: ON OFF [Default]</p> <p>Audio Source (1P) : Analog [Default] Digital (region 1)</p> <p>Audio Source (2P LR) : Analog [Default] Digital (region 1) - Left Digital (region 2) - Right</p> <p>Audio Source (2P TB) : Analog [Default] Digital (region 1) - Top Digital (region 2) - Bottom</p> <p>Audio Source (2P PIP) : Analog [Default] Digital (region 1) - Main Digital (region 2) - Sub</p> <p>Audio Source (4P) : Analog [Default] Digital (region 1) - Upper left Digital (region 2) - Lower left Digital (region 3) - Upper right Digital (region 4) - Lower right</p>
 <p>Other</p>	<p>Other:</p> <p>Reset</p> <p>Menu Time [On, 11-60] [Default 11]</p> <p>OSD H Position [0-100] [Default 50]</p> <p>OSD V Position [0-100] [Default 50]</p> <p>Language</p> <p>Transparency [0-255] [Default 0]</p> <p>Rotate: 0 [Default 0] 90 270</p> <p>Border Width: [0-10] [Default 0]</p> <p>Border Color: R [Default] G B W</p> <p>Video Wall: IR ID Assign : [0-254] [Default 0]</p>

	<p> Wall On/Off : ON : OFF [Default] Wall Size : Wall Horizontal: [1-15] [Default 1] : Wall Vertical: [1-15] [Default 1] Wall Position : X Position: [0-14] [Default 0] Wall Position : Y Position: [0-14] [Default 0] Bezel On/Off : ON : OFF [Default] </p>
	<p>Information:</p> <div style="border: 1px solid gray; padding: 5px; width: fit-content; margin: 10px auto;"> <p style="margin: 0;"> D: HDMI 3840x2160@60.1Hz H:135.1KHz PCLK: 594.4MHz HDCP Disabled </p> </div>
	<p>Factory:</p> <p> Backlight Setup: Invert : OFF [Default] ON </p> <p style="text-align: center;"> D/A / PWM : PWM [Default] D/A </p> <p> Frequency : [100Hz - 440Hz] [Default 160Hz] Min. Level : [0% - 50%] [Default 5%] </p> <p> VBy1 Setup : Pin 15 : Low [Default] High </p> <p style="margin-left: 40px;"> Pin 16 : Low [Default] High </p> <p style="margin-left: 40px;"> Pin 17 : Low [Default] High </p> <p style="margin-left: 40px;"> Pin 18 : Low [Default] High </p> <p style="margin-left: 40px;"> Pin 19 : Low [Default] High </p> <p style="margin-left: 40px;"> Pin 20 : Low [Default] High </p> <p style="margin-left: 40px;"> Pin 21 : Low [Default] High </p> <p style="margin-left: 40px;"> Pin 22 : Low [Default] High </p> <p style="margin-left: 40px;"> Pin 23 : Low [Default] High </p> <p style="margin-left: 40px;"> Pin 24 : Low [Default] High </p> <p>EDID Setup : Reset</p>

CONNECTORS, PINOUTS & JUMPERS

The various connectors are:

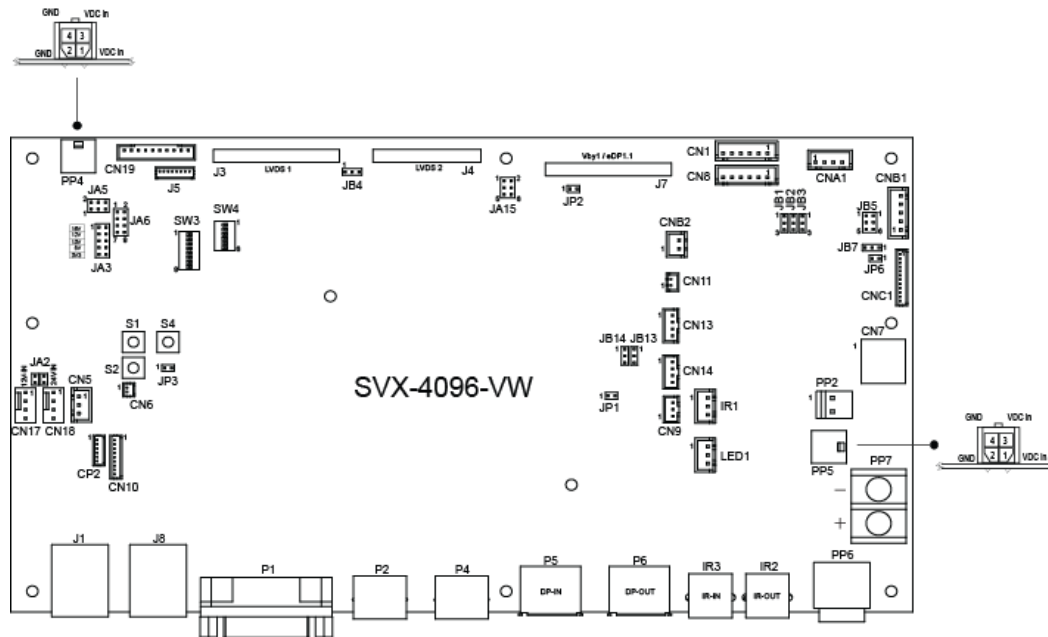

Summary: Connectors

Ref	Purpose	Description
CN1	Reserved for second RS-232 serial control	JST 6-way, B6B-XH-A (Matching type : XHP-6)
CN5	Reserved for external temperature sensor	JST 3-way, B3B-XH-A (Matching type : XHP-3)
CN6	Reserved for light sensor	DF13 2 ways (Matching type : DF13-2S-1.25C)
CN7	Audio board connector	Dual pin header 5x2, 0.1" pitch right angle (Matching audio add-on board P/N 416940020-3)
CN8	RS-232 serial control	JST 6-way, B6B-XH-A (Matching type : XHP-6)
CN9	Ambient light sensor connector	JST 3-way, B3B-PH-K (Matching type : PHR-3)
CN10	Reserved for Fan & backlight power monitoring connector	Hirose DF13-9P-1.25 DSA (Mating type : DF13-9S-1.25C)
CN11	SPDIF Audio output	JST B2B-ZR (Matching type : ZHR-2) (Matching extend cable P/N 426007400-3)
CN13	Audio line in	JST B4B-ZR (Matching type : ZHR-4)
CN14	Audio line out	JST B4B-ZR (Matching type : ZHR-4) (Use audio cable P/N 426451800-3 to connect with audio add-on board P/N 416940020-3)
CN17	Fan 1 connector	FAN connector, MKL-DP3-04W3-4
CN18	Fan 2 connector	FAN connector, MKL-DP3-04W3-4
CN19	Additional panel power output	JST B10B-PH-K (Matching type : PHR-10)
CNA1	Auxiliary power output	JST 4-way, B4B-XH-A (Matching type : XHP-4) (Matching cable P/N 426040200-3)
CNB1	Backlight inverter	JST 5-way, B5B-XH-A (Matching type : XHP-5) (Matching cable P/N 426058300-3)
CNB2	Backlight status input connector	JST 2 way, B2B-XH-A (Matching type : XHP-2)
CNC1	OSD control	Hirose DF13A-12P-1.25H (Mating type : DF13-12S-1.25C) (Matching OSD switch mount cable P/N 426122200-3 (150mm) or 426122210-3 (250mm))
CP2	Reserved	Reserved
IR1	Infra-red sensor connector	JST 3-way, B3B-XH-A (Matching type : XHP-3)
IR2	Infra-red sensor output connector	RJ-11 connector
IR3	Infra-red sensor input connector	RJ-11 connector
J1	Ethernet	RJ-45 connector
J3	LVDS 1	JAE FI-RE51S-HF (Matching type : FI-RE51HL)
J4	LVDS 2	JAE FI-RE41S-HF (Matching type : FI-RE41HL)
J5	Panel power output	JS-1147A-08 Top 1.25mm (Matching type : JS-1146-08)
J7	V-by-One panel signal output	JAE FI-RE51S-HF (Matching type : FI-RE51HL)
J8	Ethernet	RJ-45 connector
LED1	Power LED connector	JST 3-way, B3B-XH-A (Matching type : XHP-3)





Specifications subject to change without notice

P1	DVI-I -- D4 / VGA -- A0	DVI-I connector
P2	HDMI (1.4) -- D3	HDMI connector
P4	HDMI (2.0) -- D1	HDMI connector
P5	Display Port (1.2) -- D0	Display Port connector
P6	Display Port Output	Display Port connector
PP2	Power input (alternative)	DC power Molex 2 pin 0.156" pitch
PP4	External panel power input	Molex 43045-0400 compatible (Matching connector type : Molex 43025-0400 compatible) (Matching power cable : P/N 426013710-3)
PP5	12V/24VDC input power	Molex 43045-0400 compatible (Matching connector type : Molex 43025-0400 compatible) (Matching power cable : P/N 426013710-3)
PP6	12V/24VDC input power	4-way PWR DIN Jack, MDP-JRM-04
PP7	12V/24VDC input power	Terminal block, ETB5302202002
S1	Reset button (for Ethernet function)	Tact switch button
S2	Reserved	Tact switch button
S4	Config Menu button (for Ethernet function)	Tact switch button
SW3	Panel selection	8-way DIP Switch
SW4	Function selection	6-way DIP Switch

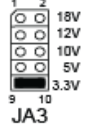

Summary: Jumpers setting

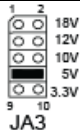
Ref	Purpose	Note
JA2	Fans Power select	24V Power input – Short 24V-IN, Open 12V-IN 12V Power input – Open 24V-IN, Short 12V-IN
JA3	Panel power voltage select CAUTION: Incorrect setting can damage panel	See panel voltage setting table 1
JA5	Panel power voltage select CAUTION: Incorrect setting will cause panel damage	See panel voltage setting table 1
JA6	Panel power voltage select CAUTION: Incorrect setting will cause panel damage	See panel voltage setting table 1
JA15	Panel power output control via J7 (pin 1-8) and J6 (pin 5-9)	1-3, 2-4 = Enable panel power (3.3/5V) output on J7 and J6 3-5, 4-6 = Enable panel power (10/12/18/24V) output on J7 and J6 Open = Disable panel power output on J7 and J6
JB1	Backlight brightness voltage range	1-2 = 5V max 2-3 = 3.3V max
JB2	Backlight inverter on/off control – signal level	2-3 = On/Off control signal 'High' = +5V 1-2 = On/Off control signal 'High' = +3.3V Open = On/Off control signal 'High' = Open collector CAUTION: Incorrect setting can damage inverter.
JB3	Backlight inverter on/off control – polarity	1-2 = control signal 'high' = Backlight ON 2-3 = control signal 'low' = Backlight ON
JB4	Reserved for LVDS (J3) GPIO pins voltage selection	1-2 = 3.3V 2-3 = 5V
JB5	Backlight control type selection	1-2 = VR/Digital switch mount control 3-4 = Analog backlight brightness - voltage range 0~5V 5-6 = PWM (Pulse Width Modulation) brightness
JB7	Backlight control voltage on CNB1 pin 4 (Function when JB5 sets 1-2 closed)	Open = For OSD switch mount control (Default) 1-2 = 0V 2-3 = 3.3V / 5V controlled by JB1
JB13	V-by-One / eDP selection on J7	1-2 = V-by-One 2-3 = eDP (1.1)
JB14	V-by-One / eDP selection on J7	1-2 = V-by-One 2-3 = eDP (1.1)
JP1	Factory use	Default Open
JP2	V-by-One power output configuration	1-2 = All pin 44 ~ pin 51 on J7 have power output Open = Only the upper four pins have power output (Refer to power output enabled/disabled on JA15. But not applicable if JA15 is set to OPEN)
JP6	Input power control	Short = External switch control and fix the board ON Open = Switch mount control

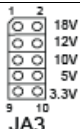
Table 1 : Panel voltage setting table :



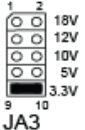

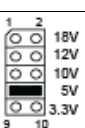
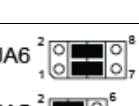
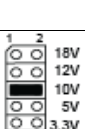
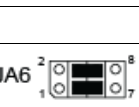
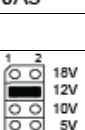
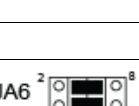
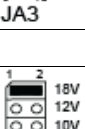



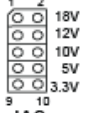

Input voltage via PP2/PP5	Panel Voltage	JA3	JA5	JA6	Jumper on board
12VDC	3.3V	3V3 closed	1-3 & 2-4	1-3 & 2-4	 
	5V	5V closed	1-3 & 2-4	1-3 & 2-4	 
	12V	OPEN	1-3 & 2-4	5-7 & 6-8	 

CAUTION: Incorrect setting can damage panel & controller

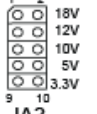
Input voltage via PP2/PP5	Panel Voltage	JA3	JA5	JA6	Jumper on board
24VDC**	3.3V	3V3 closed	1-3 & 2-4	1-3 & 2-4	 
	5V	5V closed	1-3 & 2-4	1-3 & 2-4	 
	10V	10V closed	1-3 & 2-4	3-5 & 4-6	 
	12V	12V closed	1-3 & 2-4	3-5 & 4-6	 
	18V	18V closed	1-3 & 2-4	3-5 & 4-6	 

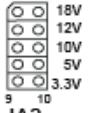
CAUTION: Incorrect setting can damage panel & controller

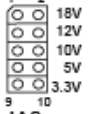
** Ensure that the backlight inverter supports 24V operation prior to connecting a 24VDC input. Because CNA1 pin 1 and CNB1 pin 2 will output 24VDC if input 24VDC via PP5 or PP2.

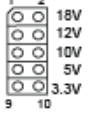
Input voltage via PP4	Input voltage via PP2 / PP5	Panel Voltage	JA3	JA5	JA6	Jumper on board
3.3 / 5 / 10 / 12 / 18VDC*	12V / 24VDC	3.3V	OPEN	3-5 & 4-6	1-3 & 2-4	  
		5V	OPEN	3-5 & 4-6	1-3 & 2-4	  
		10V	OPEN	3-5 & 4-6	3-5 & 4-6	  
		12V	OPEN	3-5 & 4-6	3-5 & 4-6	  
		18V	OPEN	3-5 & 4-6	3-5 & 4-6	  

* Maximum current for 3.3V, 5V = 7A, Maximum current for 10V, 12V = 5A, Maximum current for 18V = 3.5A

JA3, JA5 & JA6 location on board : (Please pay attention to the jumper settings on JA3, JA5 & JA6 which are red in color)

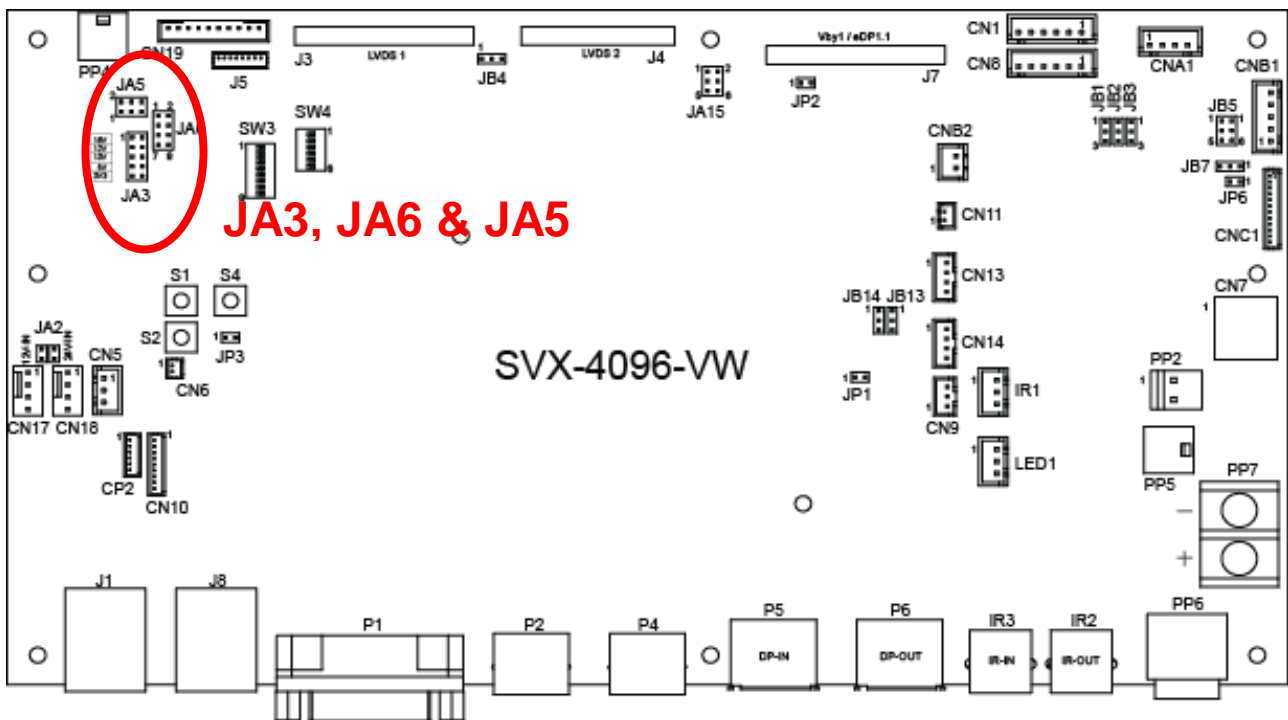

Table 2 : DIP Switch selection – SW3

Pos #1	Pos #2	Pos #3	Pos.#4	Description	Panel resolution
For 4K UHD panels					
OFF	OFF	OFF	OFF	IE-2000 (120Hz FRC)	3840 x 2160
OFF	OFF	OFF	OFF	V-By-One panel	3840 x 2160
ON	OFF	OFF	OFF	Reserved	3840 x 2160
OFF	ON	OFF	OFF	Reserved	3840 x 2160
ON	ON	OFF	OFF	Reserved	3840 x 2160
OFF	OFF	OFF	ON	Reserved	3840 x 2160
For WUXGA panels					
OFF	OFF	OFF	OFF	LVDS panel	1920 x 1200
ON	OFF	OFF	OFF	LVDS panel	1920 x 1080

Remark : The above panel timings are generated based on the panel specification. Some of the panel timings settings may not exactly to match the panel model we specified in this table.

Pos #5	Pos #6	Pos #7	Description
OFF	OFF	OFF	WUXGA (1920 x 1200 / 1080)
ON	OFF	OFF	Reserved
OFF	ON	OFF	Reserved
ON	ON	OFF	Reserved
OFF	OFF	ON	Reserved
ON	OFF	ON	Reserved
OFF	ON	ON	4K UHD (3840 x 2160)
ON	ON	ON	Others

Pos. #8	Reserved
---------	----------

Table 3 : DIP switch selection – SW4

Pos #	Function	Description															
1	LVDS data mapping	OFF: VESA ON: JEIDA															
2 and 3	Panel display division	<table border="0"> <tr> <td>Pos#3</td> <td>Pos#2</td> <td></td> </tr> <tr> <td>OFF</td> <td>OFF</td> <td>1 division (Non-division)</td> </tr> <tr> <td>OFF</td> <td>ON</td> <td>2 division</td> </tr> <tr> <td>ON</td> <td>OFF</td> <td>4 division</td> </tr> <tr> <td>ON</td> <td>ON</td> <td>8 division</td> </tr> </table>	Pos#3	Pos#2		OFF	OFF	1 division (Non-division)	OFF	ON	2 division	ON	OFF	4 division	ON	ON	8 division
Pos#3	Pos#2																
OFF	OFF	1 division (Non-division)															
OFF	ON	2 division															
ON	OFF	4 division															
ON	ON	8 division															
4	Output display bit mode	OFF: 10-bit ON: 8-bit															
5	Reserved	Reserved															
6	Reserved	Reserved															

CN1 – RS-232 serial control (2nd): JST B6B-XH-A (Matching type : XHP-6)

PIN	SYMBOL	DESCRIPTION
1	NC	No connection
2	NC	No connection
3	VCC	+5V
4	TXD	RS-232 Tx data
5	GND	Ground
6	RXD	RS-232 Rx data

CN5 – Temperature sensor connector : JST B3B-XH-A (Matching type : XHP-3)

PIN	SYMBOL	DESCRIPTION
1	GND	Ground
2	VDD	+3.3V
3	EX_TMP_SENSOR	Temperature sensor input

CN6 – Light sensor connector : DF13 2-ways (Matching type : DF13-2S-1.25C)

PIN	SYMBOL	DESCRIPTION
1	SENSOR	Light sensor input
2	VDD	+3.3V

CN7 - Audio line out : 2x5 right angled header (Matching audio add-on board P/N 416940020-3 & Audio extend cable P/N 426009700-3)

PIN	SYMBOL	DESCRIPTION
1	VCC	Audio board logic power supply, +5V
2	VOLSEL0	Reserved
3	VOLSEL1	Reversed
4	TUNAUSEL	Reserved
5	CLK/CNT	Reserved
6	GND	Ground
7	+12V/+24V	Audio board power supply, +12V/+24V
8	NC	No connection
9	NC	No connection
10	GND	Ground

CN8 – RS-232 serial control: JST B6B-XH-A (Matching type : XHP-6)

PIN	SYMBOL	DESCRIPTION
1	EXT_SCL	Reserved
2	EXT_SDA	Reserved
3	VCC	+5V
4	TXD	RS-232 Tx data
5	GND	Ground
6	RXD	RS-232 Rx data

CN9 – Ambient light sensor connector : JST B3B-PH-K (Matching type : PHR-3)

PIN	SYMBOL	DESCRIPTION
1	GND	Ground
2	VCC_5V	VCC 5V
3	ALSF	Ambient light sensing feedback

CN10 - Fan and backlight power monitoring connector : Hirose DF13-9P-1.25 DSA (Matching type : DF13-9S-1.25C)

PIN	SYMBOL	DESCRIPTION
1	GND	Ground
2	TACH1_IN	Tachometer IN of Fan 1
3	GND	Ground
4	TACH2_IN	Tachometer IN of Fan 2
5	GND	Ground
6	PS_V1_IN	Power sense input 1
7	GND	Ground
8	PS_V2_IN	Power sense input 2
9	AUX	Reserved

CN11 – SPDIF audio output connector : JST B2B-ZR (Matching type : ZHR-2)

PIN	SYMBOL	DESCRIPTION
1	SPDIF	SPDIF Digital audio output
2	GND	Ground

CN13 - Audio line in: JST B4B-ZR (Matching type : ZHR-4)

PIN	SYMBOL	DESCRIPTION
1	GND	Ground
2	LINE_IN_L	Line in (Left)

Specifications subject to change without notice

3	GND	Ground
4	LINE_IN_R	Line in (Right)

CN14 - Audio line out: JST B4B-ZR (Matching type : ZHR-4)

PIN	SYMBOL	DESCRIPTION
1	GND	Ground
2	AUDIO_OUT_L	Audio out (Left)
3	GND	Ground
4	AUDIO_OUT_R	Audio out (Right)

CN17 - Fan 2 connector

PIN	SYMBOL	DESCRIPTION
1	GND	Ground
2	+12V	+12V power supply for Fan
3	TACH1IN	RPM status
4	PWM1	Reserved

CN18 - Fan 2 connector

PIN	SYMBOL	DESCRIPTION
1	GND	Ground
2	+12V	+12V power supply for Fan
3	TACH2IN	RPM status
4	PWM2	Reserved

CN19 – Additional panel power output : JST B10B-PH-K (Matching type : PHR-10)

PIN	SYMBOL	DESCRIPTION
1	PVLCD_High	Panel power supply (+10V / 12V / 18V) (selected by JA3, JA5 & JA6)
2	PVLCD_High	Panel power supply (+10V / 12V / 18V) (selected by JA3, JA5 & JA6)
3	PVLCD_High	Panel power supply (+10V / 12V / 18V) (selected by JA3, JA5 & JA6)
4	PVLCD_High	Panel power supply (+10V / 12V / 18V) (selected by JA3, JA5 & JA6)
5	PVLCD_High	Panel power supply (+10V / 12V / 18V) (selected by JA3, JA5 & JA6)
6	GND	Ground
7	GND	Ground
8	GND	Ground
9	GND	Ground
10	GND	Ground

CNA1 - Auxiliary power output: JST B4B-XH-A (Matching type : XHP-4)

PIN	SYMBOL	DESCRIPTION
1	AUX 12V / 24V	+12V / +24V DC
2	GND	Ground
3	GND	Ground
4	AUX 5V	+5V DC, 500mA max

CNB1 – Backlight inverter connector: JST B5B-XH-A (Matching type : XHP-5)

PIN	SYMBOL	DESCRIPTION
1	GND	Ground
2	VBKL	+12V / +24V DC, backlight power supply
3	BLCTRL	On/Off control (enable) – see JB2 & JB3
4	BVR_WIP	Brightness VR – WIP
5	BVR_A	Brightness VR A

CNB2 – Backlight status input inverter connector: JST B2B-XH-A (Matching type : XHP-2)

PIN	SYMBOL	DESCRIPTION
1	BL_STATUS	Backlight status (Normal = High)
2	GND	Ground

CNC1 – OSD switch mount control, Hirose DF13A-12P-1.25H (Mating type : DF13-12S-1.25C)

PIN	SYMBOL	DESCRIPTION
1	PSWIN	Power button A
2	SW_ON	Power button B
3	BVR_A	Backlight Brightness VR pin A
4	BVR_WIP	Backlight Brightness R pin WIP
5	BVR_B	Backlight Brightness VR pin B (470 ohm resistor to +5V Vcc)
6	GND	Ground
7	MENU	OSD menu
8	-/LEFT	OSD -/Left

9	+ /RIGHT	OSD +/Right
10	SEL_DN	OSD Select down
11	SEL_UP	OSD Select up
12	NC	No connection

The VR for brightness depends on the inverter. The main power load for On/Off is handled by a relay on the controller.

CP2 - Reserved

IR1 – Infra-Red sensor connector: JST B3B-XH-A (Matching type : XHP-3)

PIN	SYMBOL	DESCRIPTION
1	GND	Ground
2	VCC	+3.3V
3	IR Data	IR data

IR2 – Infra-Red sensor connector output: RJ11 connector

PIN	SYMBOL	DESCRIPTION
1	NC	No connection
2	NC	No connection
3	NC	No connection
4	GND	Ground
5	Signal out	IR signal output
6	NC	No connection

IR3 – Infra-Red sensor connector input: RJ11 connector

PIN	SYMBOL	DESCRIPTION
1	NC	No connection
2	Signal Out	IR Signal output
3	GND	Ground
4	NC	No connection
5	Signal in	IR signal in
6	NC	No connection

J1 – Ethernet connector: RJ-45 connector

PIN	SYMBOL	DESCRIPTION
1	TX+	Transmit data +
2	TX-	Transmit data -
3	RX+	Receive data +
4	CMT1	Network use
5	CMT1	Network use
6	RX-	Receive data -
7	CMT3	Network use
8	CMT3	Network use

J3 – LVDS_1 output connector: JAE FI-RE51S-HF (Matching type : JAE FI-RE51HL)

PIN	SYMBOL	DESCRIPTION
1	VLCD_HV	Panel power supply (+10V / 12V / 18V)
2	VLCD_HV	Panel power supply (+10V / 12V / 18V)
3	VLCD_HV	Panel power supply (+10V / 12V / 18V)
4	VLCD_HV	Panel power supply (+10V / 12V / 18V)
5	VLCD_HV	Panel power supply (+10V / 12V / 18V)
6	VLCD_LV	Panel power supply (3,3V/5V)
7	VLCD_LV	Panel power supply (3,3V/5V)
8	VLCD_LV	Panel power supply (3,3V/5V)
9	VLCD_LV	Panel power supply (3,3V/5V)
10	VLCD_LV	Panel power supply (3,3V/5V)
11	GND	Ground
12	GND	Ground
13	GND	Ground
14	GND	Ground
15	GND	Ground
16	OP1	-
17	OP2	-
18	OP3	-
19	OP4	-
20	GND	Ground
21	GND	Ground
22	LVDS_OUT1_A4+	Positive differential LVDS data bit A4
23	LVDS_OUT1_A4-	Negative differential LVDS data bit A4
24	LVDS_OUT1_A3+	Positive differential LVDS data bit A3
25	LVDS_OUT1_A3-	Negative differential LVDS data bit A3
26	GND	Ground
27	LVDS_OUT1_AC+	Positive LVDS clock for A channel

Specifications subject to change without notice

28	LVDS_OUT1_AC-	Negative LVDS clock for A channel
29	GND	Ground
30	LVDS_OUT1_A2+	Positive differential LVDS data bit A2
31	LVDS_OUT1_A2-	Negative differential LVDS data bit A2
32	LVDS_OUT1_A1+	Positive differential LVDS data bit A1
33	LVDS_OUT1_A1-	Negative differential LVDS data bit A1
34	LVDS_OUT1_A0+	Positive differential LVDS data bit A0
35	LVDS_OUT1_A0-	Negative differential LVDS data bit A0
36	GND	Ground
37	LVDS_OUT1_B4+	Positive differential LVDS data bit B4
38	LVDS_OUT1_B4-	Negative differential LVDS data bit B4
39	LVDS_OUT1_B3+	Positive differential LVDS data bit B3
40	LVDS_OUT1_B3-	Negative differential LVDS data bit B3
41	GND	Ground
42	LVDS_OUT1_BC+	Positive LVDS clock for B channel
43	LVDS_OUT1_BC-	Negative LVDS clock for B channel
44	GND	Ground
45	LVDS_OUT1_B2+	Positive differential LVDS data bit B2
46	LVDS_OUT1_B2-	Negative differential LVDS data bit B2
47	LVDS_OUT1_B1+	Positive differential LVDS data bit B1
48	LVDS_OUT1_B1-	Negative differential LVDS data bit B1
49	LVDS_OUT1_B0+	Positive differential LVDS data bit B0
50	LVDS_OUT1_B0-	Negative differential LVDS data bit B0
51	GND	Ground

J4 – LVDS_2 output connector: JAE FI-RE41S-HF (Matching type : JAE FI-RE41HL)

PIN	SYMBOL	DESCRIPTION
1	GND	Ground
2	LVDS_OUT2_B0-	Negative differential LVDS data bit B0
3	LVDS_OUT2_B0+	Positive differential LVDS data bit B0
4	LVDS_OUT2_B1-	Negative differential LVDS data bit B1
5	LVDS_OUT2_B1+	Positive differential LVDS data bit B1
6	LVDS_OUT2_B2-	Negative differential LVDS data bit B2
7	LVDS_OUT2_B2+	Positive differential LVDS data bit B2
8	LVDS_OUT2_BC-	Negative LVDS clock for B channel
9	LVDS_OUT2_BC+	Positive LVDS clock for B channel
10	GND	Ground
11	LVDS_OUT2_B3-	Negative differential LVDS data bit B3
12	LVDS_OUT2_B3+	Positive differential LVDS data bit B3
13	GND	Ground
14	LVDS_OUT2_B4-	Negative differential LVDS data bit B4
15	LVDS_OUT2_B4+	Positive differential LVDS data bit B4
16	GND	Ground
17	LVDS_OUT2_A0-	Negative differential LVDS data bit A0
18	LVDS_OUT2_A0+	Positive differential LVDS data bit A0
19	LVDS_OUT2_A1-	Negative differential LVDS data bit A1
20	LVDS_OUT2_A1+	Positive differential LVDS data bit A1
21	LVDS_OUT2_A2-	Negative differential LVDS data bit A2
22	LVDS_OUT2_A2+	Positive differential LVDS data bit A2
23	LVDS_OUT2_AC-	Negative LVDS clock for A channel
24	LVDS_OUT2_AC+	Positive LVDS clock for A channel
25	GND	Ground
26	LVDS_OUT2_A3-	Negative differential LVDS data bit A3
27	LVDS_OUT2_A3+	Positive differential LVDS data bit A3
28	GND	Ground
29	LVDS_OUT2_A4-	Negative differential LVDS data bit A4
30	LVDS_OUT2_A4+	Positive differential LVDS data bit A4
31	GND	Ground
32	GND	Ground
33	GND	Ground
34	GND	Ground
35	GND	Ground
36	GND	Ground
37	NC	No connection
38	NC	No connection
39	NC	No connection
40	NC	No connection
41	NC	No connection

J5 – Panel power output connector: JS-1147A-08 Top 1.25mm (Matching type : JS-1146-08)

PIN	SYMBOL	DESCRIPTION
1	PVLCD_Low (3,3V/5V)	Panel power supply (3,3V/5V)

Specifications subject to change without notice

2	PVLCD_Low (3,3V/5V)	Panel power supply (3,3V/5V)
3	GND	Ground
4	GND	Ground
5	GND	Ground
6	PVLCD_High	Panel power supply (+10V / 12V / 18V)
7	PVLCD_High	Panel power supply (+10V / 12V / 18V)
8	PVLCD_High	Panel power supply (+10V / 12V / 18V)

J7 – V-by-One panel signal output connector: JAE FI-RE51S-HF (Matching type : JAE FI-RE51HL)

PIN	SYMBOL	DESCRIPTION
1	(51) GND	Ground
2	(50) VB1_TX7P	V-by-One HS Data Lane 7
3	(49) VB1_TX7N	V-by-One HS Data Lane 7
4	(48) GND	Ground
5	(47) VB1_TX6P	V-by-One HS Data Lane 6
6	(46) VB1_TX6N	V-by-One HS Data Lane 6
7	(45) GND	Ground
8	(44) VB1_TX5P	V-by-One HS Data Lane 5
9	(43) VB1_TX5N	V-by-One HS Data Lane 5
10	(42) GND	Ground
11	(41) VB1_TX4P	V-by-One HS Data Lane 4
12	(40) VB1_TX4N	V-by-One HS Data Lane 4
13	(39) GND	Ground
14	(38) VB1_TX3P	V-by-One HS Data Lane 3
15	(37) VB1_TX3N	V-by-One HS Data Lane 3
16	(36) GND	Ground
17	(35) VB1_TX2P	V-by-One HS Data Lane 2
18	(34) VB1_TX2N	V-by-One HS Data Lane 2
19	(33) GND	Ground
20	(32) VB1_TX1P	V-by-One HS Data Lane 1
21	(31) VB1_TX1N	V-by-One HS Data Lane 1
22	(30) GND	Ground
23	(29) VB1_TX0P	V-by-One HS Data Lane 0
24	(28) VB1_TX0N	V-by-One HS Data Lane 0
25	(27) GND	Ground
26	(26) LOCKN	V-by-One LOCK
27	(25) HTPDN	V-by-One HTPDN
28	(24) OP10	High/Low state control
29	(23) OP9	High/Low state control
30	(22) OP8	High/Low state control
31	(21) OP7	High/Low state control
32	(20) OP6	High/Low state control
33	(19) OP5 / PANEL_SCL	High/Low state control / Panel I ² C SCL
34	(18) OP4 / PANEL_SDA	High/Low state control / Panel I ² C SDA
35	(17) OP3	High/Low state control
36	(16) OP2	High/Low state control
37	(15) OP1	High/Low state control
38	(14) GND	Ground
39	(13) GND	Ground
40	(12) GND	Ground
41	(11) GND	Ground
42	(10) GND	Ground
43	(9) NC	No Connection
44	(8) PVLCD_High	Panel power supply (selected by JA15 & JP2)
45	(7) PVLCD_High	Panel power supply (selected by JA15 & JP2)
46	(6) PVLCD_High	Panel power supply (selected by JA15 & JP2)
47	(5) PVLCD_High	Panel power supply (selected by JA15 & JP2)
48	(4) PVLCD_High	Panel power supply (selected by JA15 & JP2)
49	(3) PVLCD_High	Panel power supply (selected by JA15 & JP2)
50	(2) PVLCD_High	Panel power supply (selected by JA15 & JP2)
51	(1) PVLCD_High	Panel power supply (selected by JA15 & JP2)

(1) - (51): Pin# read on panel side.

J8 – Ethernet connector: RJ-45 connector

PIN	SYMBOL	DESCRIPTION
1	TX+	Transmit data +
2	TX-	Transmit data -
3	RX+	Receive data +
4	CMT1	Network use
5	CMT1	Network use
6	RX-	Receive data -
7	CMT3	Network use
8	CMT3	Network use

Specifications subject to change without notice

LED1 – Status LED connector: JST 3-way B3B-XH-A 3-pin header

PIN	DESCRIPTION
1	Green LED pin (anode)
2	LED pin common (cathode)
3	Red LED pin (anode)

P1 – DVI-I (Dual link) in

PIN	SYMBOL	DESCRIPTION
1	/RX2	TMDS Data 2-
2	RX2	TMDS Data 2+
3	GND	Digital Ground
4	/Rx4	TMDS Data 4-
5	Rx4	TMDS Data 4+
6	DDC_CLK	DDC Clock
7	DDC_DAT	DDC Data
8	VS_IN	Analog Vertical Sync
9	/RX1	TMDS Data 1-
10	RX1	TMDS Data 1+
11	GND	Digital Ground
12	/Rx3	TMDS Data 3-
13	Rx3	TMDS Data 3+
14	DDC_5V	+5V power supply for DDC (optional)
15	GND	Ground
16	HPD	Hot Plug Detect
17	/RX0	TMDS Data 0-
18	RX0	TMDS Data 0+
19	GND	Digital Ground
20	/Rx5	TMDS Data 5-
21	Rx5	TMDS Data 5+
22	GND	Digital Ground
23	RXC	TMDS Clock+
24	/RXC	TMDS Clock-
C1	RIN	Analog Red
C2	GIN	Analog Green
C3	BIN	Analog Blue
C4	HS_IN	Analog horizontal sync
C5	GND	Ground
C6	NC	No connection

P2 – HDMI (1.4) connector

PIN	SYMBOL	DESCRIPTION
1	DATA2+	TMDS Data2+
2	DATA2S	TMDS Data2 Shield
3	DATA2-	TMDS Data2-
4	DATA1+	TMDS Data1+
5	DATA1S	TMDS Data1 Shield
6	DATA1-	TMDS Data1-
7	DATA0+	TMDS Data0+
8	DATA0S	TMDS Data0 Shield
9	DATA0-	TMDS Data0-
10	CLK+	TMDS Clock+
11	CLK@	TMDS Clock Shield
12	CLK-	TMDS Clock-
13	NC	No connection
14	NC	No connection
15	SCL	SCL (I ² C Serial Clock for DDC)
16	SDA	SDA (I ² C Serial Data Line for DDC)
17	GND	Ground
18	+5V	+5 V Power (max 50 mA)
19	HPDET	Hot Plug Detect

P4 – HDMI (2.0) connector

PIN	SYMBOL	DESCRIPTION
1	DATA2+	TMDS Data2+
2	DATA2S	TMDS Data2 Shield
3	DATA2-	TMDS Data2-
4	DATA1+	TMDS Data1+
5	DATA1S	TMDS Data1 Shield
6	DATA1-	TMDS Data1-
7	DATA0+	TMDS Data0+

8	DATA0S	TMDS Data0 Shield
9	DATA0-	TMDS Data0-
10	CLK+	TMDS Clock+
11	CLK@	TMDS Clock Shield
12	CLK-	TMDS Clock-
13	NC	No connection
14	NC	No connection
15	SCL	SCL (I ² C Serial Clock for DDC)
16	SDA	SDA (I ² C Serial Data Line for DDC)
17	GND	Ground
18	+5V	+5 V Power (max 50 mA)
19	HPDET	Hot Plug Detect

P5 – Display Port (1.2) connector

PIN	SYMBOL	DESCRIPTION
1	ML_Lane 0 (p)	Lane 0 (positive)
2	GND	Ground
3	ML_Lane 0 (n)	Lane 0 (negative)
4	ML_Lane 1 (p)	Lane 1 (positive)
5	GND	Ground
6	ML_Lane 1 (n)	Lane 1 (negative)
7	ML_Lane 2 (p)	Lane 2 (positive)
8	GND	Ground
9	ML_Lane 2 (n)	Lane 2 (negative)
10	ML_Lane 3 (p)	Lane 3 (positive)
11	GND	Ground
12	ML_Lane 3 (n)	Lane 3 (negative)
13	CONFIG1	connected to Ground
14	CONFIG2	connected to Ground
15	AUX CH (p)	Auxiliary Channel (positive)
16	GND	Ground
17	AUX CH (n)	Auxiliary Channel (negative)
18	Hot Plug	Hot Plug Detect
19	GND	Ground
20	DP_PWR	Power for connector (3.3 V 500 mA)

P6 – Display Port out connector

PIN	SYMBOL	DESCRIPTION
1	ML_Lane 0 (p)	Lane 0 (positive)
2	GND	Ground
3	ML_Lane 0 (n)	Lane 0 (negative)
4	ML_Lane 1 (p)	Lane 1 (positive)
5	GND	Ground
6	ML_Lane 1 (n)	Lane 1 (negative)
7	ML_Lane 2 (p)	Lane 2 (positive)
8	GND	Ground
9	ML_Lane 2 (n)	Lane 2 (negative)
10	ML_Lane 3 (p)	Lane 3 (positive)
11	GND	Ground
12	ML_Lane 3 (n)	Lane 3 (negative)
13	CONFIG1	connected to Ground
14	CONFIG2	connected to Ground
15	AUX CH (p)	Auxiliary Channel (positive)
16	GND	Ground
17	AUX CH (n)	Auxiliary Channel (negative)
18	Hot Plug	Hot Plug Detect
19	GND	Ground
20	DP_PWR	Power for connector (3.3 V 500 mA)

PP2 – Alternate 12V/24VDC input power: Molex 2 pin 0.156" pitch

PIN	DESCRIPTION
1	+12VDC / 24VDC in
2	Ground

PP4 – External panel power input: Molex 43045-0400 or compatible (Matching type : Molex 43025-0400 or compatible)

PIN	DESCRIPTION
1	External panel power
2	Ground
3	External panel power
4	Ground

PP5 – 12V/24VDC input power: Molex 43045-0400 or compatible (Matching type : Molex 43025-0400 or compatible)

PIN	DESCRIPTION
1	+12VDC / 24VDC in
2	Ground
3	+12VDC / 24VDC in
4	Ground

PP6 – Alternate 12V/24VDC input power: 4-way PWR DIN Jack MDP-JRM-04

PIN	DESCRIPTION
1	Ground
2	External panel power
3	Ground
4	External panel power

PP7 – Alternate 12V/24VDC input power: Terminal block ETB5302202002

PIN	DESCRIPTION
1	External panel power
2	Ground

CONTROLLER DIMENSIONS

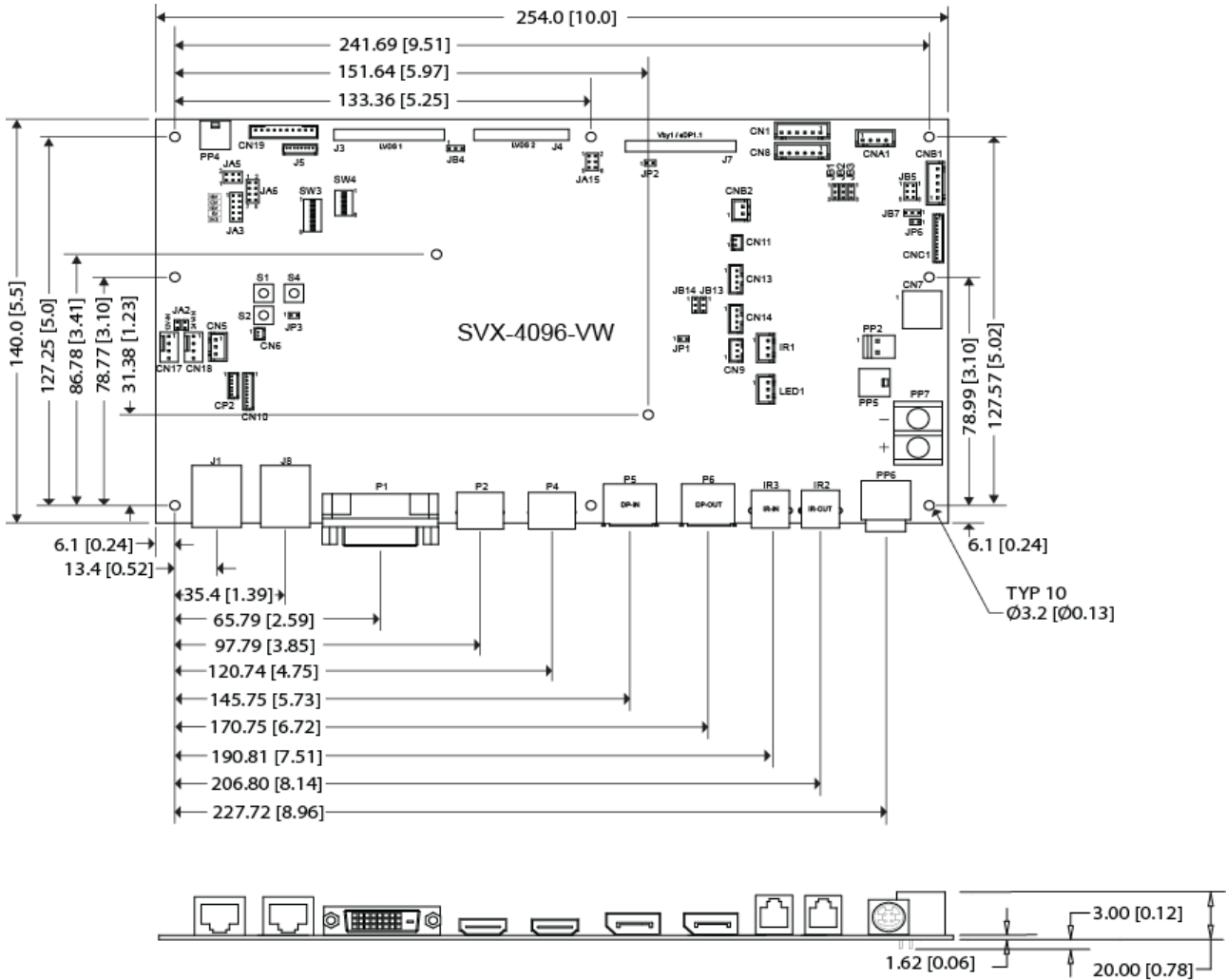

Ready-made 3D Pro-E (SLDPRT) drawing files - Save time and effort for your system volumetric analysis design. Includes jpg file previews. Please go to download at <http://www.digitalview.com/products/SVX-4096-VW-lcd-controller>

The maximum thickness of the controller is 18.93mm with or without video add-on board (measured from bottom of PCB to top of components, including any underside components & leads). We recommend clearances of:

- 5mm from bottom of PCB - if mounting on a metal plate we also recommend a layer of suitable insulation material is added to the mounting plate surface.
- 10mm above the components
- 3-5mm around the edges

Any of the holes shown above can be used for mounting the PCB, they are 3.2mm in diameter.

CAUTION: Ensure adequate insulation is provided for all areas of the PCB with special attention to high voltage parts such as the inverter.

APPLICATION NOTES

USING THE CONTROLLER WITHOUT BUTTONS ATTACHED

This is very straightforward:

- Firstly setup the controller/display system with the buttons. With controls attached and display system active make any settings for color, tint and image position as required then switch everything off.
- Remove the control switches, the 12-way (CNC1) cable.
- Use a jumper or similar to connect pins 1 & 2 on JP6, this will fix the board On.
- Refer to inverter specifications for details as to fixing brightness to a desired level, this may require a resistor, an open circuit or closed circuit depending on inverter.

Summary: On CNC1 the only pins that are used are for On/Off and Brightness (if controller mounted inverter is used). On CNC1 the pins are for momentary type buttons so it doesn't matter that no buttons are attached.

INVERTER CONNECTION

There are potentially 3 issues to consider with inverter connection:

- Power
- Enable
- Brightness

Please read the following sections for a guide to these issues.

Inverter Power: As per the table for CNB1 pin 1 is ground and pin 2 provides 12V/24V DC. This should be matched with the inverter specification: see table.

CNB1

PIN	DESCRIPTION
1	Ground
2	+12V/+24VDC

Remark: For higher power inverter, more current (for 12V/24V) can be taken from CNA1 pin 1.

Enable: This is a pin provided on some inverters for On/Off function and is used by this panel controller for VESA DPMS compliance. If the inverter does not have an enable pin or the enable pin is not used then DPMS will not be operational. Pin 3 should be matched to the inverters specification for the 'enable' or 'disable' pin.

CNB1

PIN	DESCRIPTION
3	Enable

Further, jumpers JB2 & JB3 should be set to match the inverters specification for the enable pin power and High or Low setting: see table.

Ref	Purpose	Note
JB2	Inverter enable voltage	1-2 H = 3.3V, 2-3 H = 5V, OPEN H = open collector
JB3	Inverter control	1-2 H = On, 2-3 L = On

Brightness: There are various methods for brightness control and it is important to consider the specifications for the inverter to be used. Generally the situation is:

- Brightness can control by using a resistor or VR (Variable Resistor).
- Brightness controlled by adding a circuit such as PWM (Pulse Width Modulation).
- No adjustment of brightness is possible.

CNB1 pins 4 & 5 are available for connecting to an inverter or circuit where VR control is supported.

CNB1

PIN	DESCRIPTION
4	VR WIP
5	VR A

This can then be matched with function controls connected to CNC1 pins 4 & 3 or 5: see table.

CNC1

PIN	DESCRIPTION
3	VR A
4	VR WIP
5	VR B

Design Guideline for making VR circuitry :

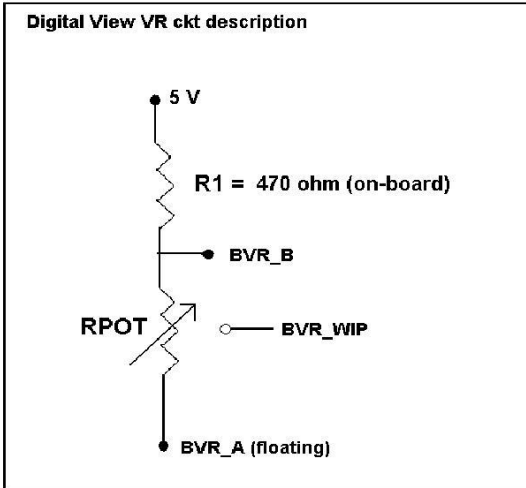

Signal description / Notes :

- 1) R1 : 470ohm on board
- 2) RPOT is an external potentiometer (in-line dip style) that can be plugged directly into CNC1 pins 3,4,5. RPOT must be supplied / installed by user.
- 3) BVR_B : Voltage tapped from “top” of potentiometer, the node of R1 and RPOT.
- 4) BVR_WIP : Voltage tapped from wiper arm of RPOT.
- 5) BVR_A : Voltage tapped from “bottom” of RPOT.

Note : BVR_A voltage is left floating on the controller board. To use this circuit, you need to tie this point to a potential (usually GND, available at CNC1 pin 6).

CNB1 – Backlight inverter connector: JST B5B-XH-A (Matching type : XHP-5)

PIN	SYMBOL	DESCRIPTION
1	GND	Ground
2	VBKL	+12V/24VDC, backlight power supply
3	BLCTRL	On/Off control (enable) – see JB2 & JB3
4	BVR_WIP	Brightness VR - WIP
5	BVR_A	Brightness VR A

CNC1 – OSD switch mount control, Hirose DF13A-12P-1.25H (Mating type : DF13-12S-1.25C)

PIN	SYMBOL	DESCRIPTION
1	PSWIN	Power button A
2	SW_ON	Power button B
3	BVR_A	Backlight Brightness VR pin A
4	BVR_WIP	Backlight Brightness R pin WIP
5	BVR_B	Backlight Brightness VR pin B (470 ohm resistor to +5V Vcc)
6	GND	Ground
7	MENU	OSD menu
8	-/LEFT	OSD -/Left
9	+ /RIGHT	OSD +/Right
10	SEL_DN	OSD Select down
11	SEL_UP	OSD Select up
12	NC	No connection

The VR for brightness depends on the inverter. The main power load for On/Off is handled by a relay on the controller.

Example for circuit design :

- 1.) Choose RPOT = 10K
- 2.) Tie BVR_A to GND
- 3.) Circuit analysis gives BVR_WIP as the following (see Figure 1)

$$BVR_WIP = 5 \times (Rbc/10.47)$$

where BVR_WIP is in Volts.
And Rbc is the resistance from the wiper arm to bottom of pot in Kohms.

To evaluate, plug in different values of Rbc :

Rbc	BVR_WIP
0	0 V
2.5 K	1.2 V
5 K	2.4 V
7.5 K	3.6 V
10 K	4.8 V

So this circuit could provide Brightness adjust voltage ranging from 0V to 5V.

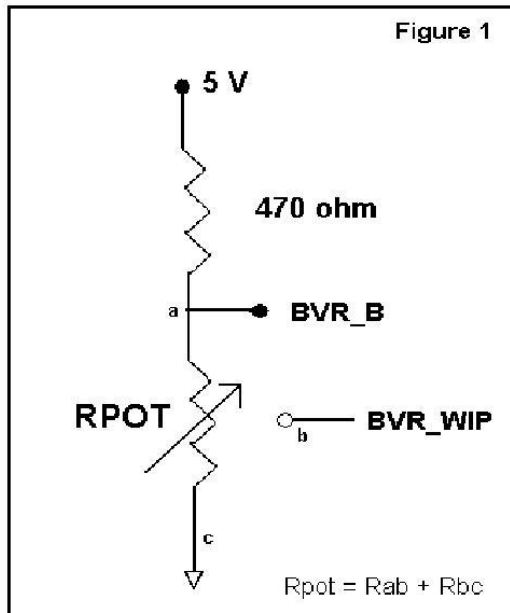

TROUBLESHOOTING

General

A general guide to troubleshooting a flat panel display system it is worth considering the system as separate elements, such as:

- Controller (jumpers, PC settings)
- Panel (controller, cabling, connection, panel, PC settings)
- Backlight (inverter, cabling, backlight tubes)
- Cabling
- Computer system (display settings, operating system)

Through step by step cross checking with instruction manuals and a process of elimination to isolate the problem it is usually possible to clearly identify the problem area.

No image:

- If the panel backlight is not working it may still be possible to just see some image on the display.
- A lack of image is most likely to be caused by incorrect connection, lack of power, failure to provide a signal or incorrect graphic card settings.

Image position:

If it is impossible to position the image correctly, i.e. the image adjustment controls will not move the image far enough, then test using another graphics card. This situation can occur with a custom graphics card that is not close to standard timings or if something is in the graphics line that may be affecting the signal such as a signal splitter (please note that normally a signal splitter will not have any adverse effect).

Image appearance:

- A faulty panel can have blank lines, failed sections, flickering or flashing display
- Incorrect graphics card refresh rate, resolution or interlaced mode will probably cause the image to be the wrong size, to scroll, flicker badly or possibly even no image.
- Incorrect jumper settings on the controller may cause everything from total failure to incorrect image. CAUTION: Do not set the panel power input incorrectly.
- Sparkling on the display: faulty panel signal cable.

Backlight:

Items to check include: Power input, Controls, Inverter and Tubes generally in this order.

If half the screen is dimmer than the other half:

- Check cabling for the inverter.
- For a specific backlight tube check the AC pins orientation (CAUTION: Never reverse any DC power pins).

Also:

- If adjusting brightness control has no effect the chances are that the VR rating or method of adjusting brightness is not compatible or correctly connected to the inverter.
- If system does not power down when there is a loss of signal

Continued failure:

If unit after unit keeps failing consider and investigate whether you are short circuiting the equipment or doing something else seriously wrong.

Generally after common sense issues have been resolved we recommend step by step substitution of known working parts to isolate the problem.

The following are some of LED indicators onboard that can help to know the health status of the controller board:

LED1A

- Green : Valid video signal received on the selected input port.
- Red : No video signal received on the selected input port.
- Green + Red : The board is fail to boot up. Suggest to send it back to factory for check.
- Off : The board is not powered on.

LED2

- Green : +3.3V / +5V power is supplied to panel.
- Red : +10V / +12V / +18V power is supplied to panel.
- Off : No power is supplied to panel.

D2 (for V-by-One panel only)

- Green : V-by-One LOCKN signal is set to LOW by panel when CDR (clock data recovery) training is done and CDR is locked.

SPECIFICATIONS

Panel compatibility	Compatible with 4096x2160 resolutions of TFT LCD panels with V-by-One /LVDS panel interface. A specified BIOS and some factory adjustment is required for individual panel timings.
No. of colors	Up to 3 x 10 bit providing 1.06 billion colors.
Panel power	DC 3.3V, 5V, 10V, 12V, 18V
Panel signal	V-by-One (8 Lane) LVDS (4 channel)
Video inputs	DVI-I (Dual Link) Display Port 1.2 HDMI 1.4 HDMI 2.0
Video output (Daisy chain)	Display Port 1.2 out
Functions display	On screen display (OSD) of functions
OSD menu functions	Image controls: Panel brightness/contrast, Saturation, Hue, Color temperature, Sharpness, Aspect ratio, Rotate, Gamma, PIP/PBP.
OSD menu controls available	Power On/Off OSD Menu OSD Select up OSD Select down Setting + Setting -
Control interface	Buttons, RS-232, IR Remote control (Daisy chain), Ethernet control (Daisy chain)
Audio	Digital audio line out (from header) with OSD volume control. (not amplified)
Settings memory	Settings are stored in non volatile memory
PC Connectivity	VGA / SVGA / XGA / SXGA / UXGA / WUXGA analog or digital
Controller dimensions	254mm x 140mm (10" x 5.5")
Power consumption	10W approx. (not including panel power consumption)
Power load maximum	The controller has an overall 3Amp current limit.
Input voltage	12V/24VDC +/- 5%
On board battery lifetime	3 years at storage (without applying power to the unit). The battery is not rechargeable.
Power protection	Fuse fitted (Resettable)
DC Power handling	Reverse power polarity protection is equipped on the board
Storage temperature limits	-40°C to +70°C
Operating temperature limits	0°C to +60°C

NOTES

Please note the following:

- For specific panel setup a sample of an LCD may be required (this will be returned) and a copy of the full technical specifications for the panel from the manufacturer.
- Re-layout and custom development services are available.

Appendix I – Network connection (Daisy chain)

The SVX-4096-VW LCD interface controller has an RJ-45 Ethernet port (Daisy chain) for control and monitoring over a network. This application note introduces the two user interface modes:

- Command line direct mode
- Browser based web server mode

There is also a short overview of the command set and how it is implemented.

QUICK GUIDE

For experienced users the following quick guide to trying out the network connection and functions may be useful.

Command line direct mode: This is relevant when a PC application is used to send and receive commands over the network port.

Browser based web server mode : The network port will require an alternative firmware version if the browser based web server mode is required.

- Works with a normal network with DHCP, i.e. must use a router.
- Connect the SVX-4096-VW to the network and ensure power is on.
- Use the IP Locator utility available from the IP-60 web-page.
<http://www.digitalview.com/media/downloads/IPLocator.zip> (Windows only)
- Double click on the IP address in the IP Locator window, it will open the SVX-4096-VW browser page in your default browser. Alternatively copy the IP address into your browser address line.
- Test the functions that come up on the browser. The function list on browser can be found in Appendix VII.

For details, please refer to the separate application note.

Appendix II – RS-232 control protocols and command set

RS-232 Serial control (Baud rate 2400), 8 bits, 1 stop bit and no parity

Physical connection :

Controller side
Connector interface : CN8
Mating connector : JST XHP-6

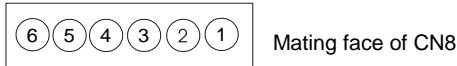

PIN#	Description
4	RS-232 Tx Data
5	Ground
6	RS-232 Rx Data

Computer side
Connector interface : Serial port
Mating connector : DB9 Female

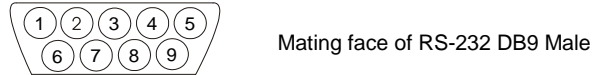

PIN#	Description
2	RS-232 Rx Data
3	RS-232 Tx Data
5	Ground

Remark :

(1) : RS-232 connection cable, 600mm P/N 426090200-3 can be ordered separately for connection.

Software connection :

The OSD function can be controlled through sending the RS-232 protocol.

The RS-232 program can be custom-made to fit for application or it can be used the serial control program, like Accessport, Telix or Serial Utility program developed by DigitalView. Please contact your local support for information.

1. Commands to implement switch mount control buttons

Function	Command	Description	Remark
Menu button	0xf7	Menu button pressed	Button equivalent
Select-down button	0xfa	Select-down button pressed	Button equivalent
Select-up button	0xfb	Select-up button pressed	Button equivalent
Right/+ button	0xfc	Right/+ button pressed	Button equivalent
Left/- button	0xfd	Left/- button pressed	Button equivalent

2. Parameter setting - immediate, relative, reset and query

Function	Command	Description	Acknowledge (if enabled)
Volume control - left+right channel	0x80, "a" "A", nn "+" "-" "r" "R" "?"	Set audio (L+R) volume = value/increment/decrement Reset Query	nn = 0x00~ 0x64 (0~100%) Default: 0x32 (50%)
Volume control - on/off (mute)	0x80, "m" "M", "0" "1" "r" "R" "?"	Disable audio output. Enable audio output. Reset Query	"0" - audio off (mute). "1" - audio on. (Default)
Audio selection	0x80, "P", "n" "?" "r" "R"	Select Audio Output Query Reset	"n" = "0" - P1 (upper left picture) (Default) "1" - P2 (lower left picture) "2" - P3 (upper right picture) "3" - P4 (lower right picture) "A/a" – Analog source Note: P1~P4 audio source is available when video source is either DP or HDMI
Brightness control	0x81, nn "+" "-" "r" "R" "?" "m" "n"	Set brightness = value/increment/decrement Reset Query Current Source Maximum query Minimum query	nn = 0x00~ 0x64 (0~100%) Default: 0x32 (50%)
Contrast control	0x82, "a" "A", nn "+" "-" "r" "R" "?" "m" "n"	Set contrast = value/increment/decrement Reset Query Maximum query Minimum query	nn = 0x00~ 0x64 (0~100%) Default: 0x32 (50%)
Color saturation control	0x83, nn "+" "-" "r" "R" "?" "m" "n"	Set color saturation = value/increment/decrement Reset Query Maximum query Minimum query	nn = 0x00~ 0x64 (0~100%) Default: 0x32 (50%)
Hue control	0x84, nn "+" "-" "r" "R" "?" "m" "n"	Set tint = value/increment/decrement Reset Query Maximum query Minimum query	nn = 0x00~ 0x64 (0~100%) Default: 0x32 (50%)
Phase control (only for VGA port)	0x85, nn "+" "-" "?"	Set phase = value/increment/decrement Query	nn = 0x00~ 0x64 (0~100%)
Image H position	0x86,	Set horizontal position =	nn = 0x00~ 0x64 (0~100%)

Specifications subject to change without notice

(only for VGA port)	nn "+" "-" "r" "R" "?"	value/increment/decrement Reset Query	
Image V position (only for VGA port)	0x87, nnnn "+" "-" "r" "R" "?"	Set vertical position = value/increment/decrement Reset Query	nn = 0x00~ 0x64 (0~100%) Default: 0x32 (50%)
Sharpness	0x8a, n "+" "-" "r" "R" "?"	Set sharpness = value/increment/decrement Reset Query	nn = 0x00~ 0x64 (0~100%) Default: 0x32 (50%)
Clock control (only for VGA port)	0x8b, nn "+" "-" "?"	Set VGA clock= Value/increment/decrement Query	nn = 0x00~ 0x64 (0~100%)
Aspect Ratio	0x8c, "0" "1" "9" "A" "F" "R" "?"	Set video aspect ratio= Value Reset Query	"0" – 1:1 "1" – fill screen (Default) "9" – 4:3 "A" – 16:9 "F" – 5:4
Set display orientation	0x8e, n "r" "R" "?"	Set display orientation = value Reset Query	"0" – normal (0 degree) (Default) "4" – rotated 90 "5" – rotated 180 "6" – rotated 270 Note: Rotation is only allowed in 1P mode
Rotate OSD	0x8f, "0" "1" "3" "?"	Normal OSD rotate rotated 90 rotated 270 Query	"0" – normal OSD. (Default) "1" – rotated 90 OSD. "3" – rotated 270 OSD.
OSD H position	0x90, nn "+" "-" "r" "R" "?"	Set OSD horizontal position = value/increment/decrement Reset Query	nn = 0x00~ 0x64 (left ~ right) Default: 0x32 (middle)
OSD V position	0x91, nn "+" "-" "r" "R" "?"	Set OSD vertical position = value/increment/decrement Reset Query	nn = 0x00~ 0x64 (top ~ bottom) Default: 0x32 (middle)
OSD transparency	0x92, nn "+" "-" "r" "R" "?"	Set OSD transparency = value/increment/decrement Reset Query	nn = 0x00~ 0x64 (0~100%) Default: 0x00 (No transparency)
OSD menu timeout	0x93, nn "+" "-" "r" "R" "?"	Select menu timeout = value/increment/decrement Reset Query	OSD menu timeout value. nn = 0x0A – Always on nn = 0x0B - 0x3C (11~60sec) Default: 0x0B (11sec)
Input main video (P1) select	0x98, nn "+" "-" "r" "R" "?"	Select P1 video input = value/next input/previous input Reset Query	"nn" = "0x41,0x31" A0: VGA "0x50, 0x31" D0: DP (Default) "0x48,0x31" D1: HDMI "0x48,0x32" D2: HDMI "0x46,0x31" D4: DVI
Auto source seek	0x99, "0" "1" "r" "R" "?"	Set auto source seek = Disable/Enable Reset Query	Default: "1" (Enable)
Source Layout	0x9a, n "r" "R" "?"	Select video source layout = Single, PIP , PBP, 4P Reset, Query	"n": "0"- 1P (Single) (Default) "1"- 2P PIP "2"- 2P PBP (Left Right)

			"3"- 2P PBP (Top Bottom) "4"- 4P
GAMMA value select	0x9d, n "r" "R" "?"	Select GAMMA value = Value Reset Query	"n": "5" – 1.8, "7" – 2.0, "2" – 2.2, (Default) "A" – 2.4
Auto power off	0x9f, "0" "1" "r" "R" "?"	Set auto power save option = Disable/Enable Reset Query	"n": "0" – Disable auto power off "1" – Enable auto power off (Default)
Hot key 1 (plus and minus keys)	0xa0, "1", n "r" "R" "?"	Set Hot key 1= Value Reset Query	"n": "1" – volume "2" – brightness "3" – contrast "4" – color saturation "5" – input source (P1 source) "9" – PIP size "B" – No hot key function (Default) "D" – PIP Swap "E" – Aspect ratio "G" – Hue "H" – Backlight level "I" – VGA Auto picture adjust "L" - Sharpness "M" - Display mode (select 1P, 2P PIP, 2P PBP or 4P)
Hot key 2 (up and down keys)	0xa0, "2", n "r" "R" "?"	Set Hot key 2= Value Reset Query	"n": "1" – volume "2" – brightness "3" – contrast "4" – color saturation "5" – input source (P1 source) "9" – PIP size "B" – No hot key function (Default) "D" – PIP Swap "E" – Aspect ratio "G" – Hue "H" – Backlight level "I" – VGA Auto picture adjust "L" - Sharpness "M" - Display mode (select 1P, 2P PIP, 2P PBP or 4P)
Runtime counter	0xa1, nnnnn "r" "R" "?"	Set runtime counter value = nnnnn (* 0.5 hour) Reset to zero Query	Runtime = nnnnn. Max. input = 0x1ffe (0x1ffe * 0.5 hour = 65535 hours) Runtime counter counts when backlight is on
PIP H position	0xa4, nn "+" "-" "r" "R" "?"	Set PIP horizontal position= value/go right/go left Reset Query	PIP window horizontal position. nn: 0x00(left)~0x64(right) Default: 0x64
PIP V position	0xa5, nn "+" "-" "r" "R" "?"	Set PIP vertical position= value/go down/go up Reset Query	PIP window vertical position. nn: 0x00(top)~0x64(bottom) Default: 0x64
PIP window size select	0xa6, nn "r" "R" "?"	Select PIP window size = PIP window size value Reset Query	nn: 0x00(smallest)~0x0A (largest) Default: 0x0A

PIP /P2 source select	0xa7, nn "r" "R" "?"	Select PIP or P2 video source = Video source value Reset Query	P2 is: 2P PBP left right: right window 2P PBP top bottom: bottom window 4P: lower left window "nn" = "0x41,0x31" A0: VGA "0x50,0x31" D0: DP "0x48,0x31" D1: HDMI (Default) "0x48,0x32" D2: HDMI "0x45,0x31" D3: HD-SDI (for custom code only) "0x46,0x31" D4: DVI Please note that PIP or PBP mode should be enabled first before select video source.
P3 source select	0xa7, "c" nn "r" "R" "?"	Select P3 video source = Video source value Reset Query	P3 is upper right window in 4P mode "nn" = "0x41,0x31" A0: VGA "0x50,0x31" D0: DP "0x48,0x31" D1: HDMI "0x48,0x32" D2: HDMI (Default) "0x45,0x31" D3: HD-SDI (for custom code only) "0x46,0x31" D4: DVI Please note that 4P PBP mode should be enabled first before select video source.
P4 source select	0xa7, "d" nn "r" "R" "?"	Select P4 video source = Video source value Reset Query	P4 is lower right window in 4P mode "nn" = "0x41,0x31" A0: VGA "0x50,0x31" D0: DP "0x48,0x31" D1: HDMI "0x48,0x32" D2: HDMI "0x45,0x31" D3: HD-SDI (Default, for custom code only) "0x46,0x31" D4: DVI Please note that 4P PBP mode should be enabled first before select video source.
Colour temperature select	0xb3, n "r" "R" "?"	Select colour temperature = value Reset Query	"n" = "2" – 6500K. (Default) "4" – User "5" – 9300K "6" – 7500K "7" – 5800K "8" – sRGB "9" – 3200K "A" – 2600K (custom code)
Red level of User colour temperature	0xb4, nn "+" "-" "r" "R" "?" "m" "n"	Set the level of the red channel for the user colour temp. = value/increment/decrement Reset Query Maximum query Minimum query	nn: 0x00~ 0xff (0~255) Default: 0x80

Green level of User colour temperature	0xb5, nn "+" "-" "r" "R" "?" "m" "n"	Set the level of the green channel for the user colour temp. = value/increment/decrement Reset Query Maximum query Minimum query	nn: 0x00~ 0xff (0~255) Default: 0x80
Blue level of User colour temperature	0xb6, nn "+" "-" "r" "R" "?" "m" "n"	Set the level of the blue channel for the user colour temp. = value/increment/decrement Reset Query Maximum query Minimum query	nn: 0x00~ 0xff (0~255) Default: 0x80
Video horizontal resolution enquiry	0xb7	Horizontal resolution (in pixels) in 3 to 4 digit hex number	
Video vertical resolution enquiry	0xb8	Vertical resolution (in lines) in 3 digit hex number	
Video horizontal sync frequency	0xb9	Horizontal sync frequency (in units of 100Hz) in 3 digit hex number	
Video vertical sync frequency	0xba	Vertical sync frequency (in units of Hz) in 3 digit hex number and 1 char	"nnnc" = vertical frequency nnn = 3 digit hex c= "i" (interlace) or "p" (progressive)
OSD status enquiry	0xbb	Status of OSD	"0" – OSD turned off "1" – OSD turned on
Display video information box	0xbc, "?" "0" "1"	Query No video info box shown After switching to a new video source, the video info box is displayed for 5 seconds.	"0" – disabled. "1" – enabled. (Default)
OSD turn off	0xbd	Turn off the OSD.	"0" – fail. "1" – successful.
Saving the Calibrated default	0xd7	Saving all parameters to user default value	"1" – successful
Loading the Calibrated default	0xd8	Loading all parameters to user default value	"1" – successful "0" – not successful
Display Video Wall ID	0xdd,0x41 "0" "1" "?"	Clear ID on Panel Display ID on Panel Query.	"0" "1" "0" "1"
Video Wall Enable	0xdd,0x43 "0" "1" "R" "r" "?"	Enable Video Wall = Enable Disable Reset (Default Disable) Query	"1" Enable "0" Disable
Video Wall Bezel Enable	0xdd 0x44, "0" "1" "r" "R" "?"	Command Disable Bezel Compensation Enable Bezel Reset Query	
Video Wall horizontal active dimension	0xdd 0x45, "nnnn" ?	Command Value Query	
Video Wall vertical active dimension	0xdd 0x46 "nnnn" ?	Command Value Query	
Video Wall horizontal bezel dimension	0xdd 0x47 "nnnn" ?	Command Value Query	

Video Wall vertical bezel dimension	0xdd 0x48 "nnnn" ?"	Command Value Query	
Backlight control	0xe0, nn "+" "-" "R" "r" "?"	Set Backlight level = value/increment/decrement Reset Query	nn = 0x00~ 0x64 (0~100%) Default: 0x64 (100%)
Backlight On/Off	0xe1, "0" "1" "R" "r" "?"	Backlight Off / Backlight On Reset Query	"0" – Backlight Off "1" – Backlight On. (Default)
Swap PIP / 2P PBP video source	0xe3	Swap Main and PIP Source (PIP mode), left & right source (PBP LR) or Top & Bottom (PBP TB)	"0" – fail. "1" – successful.
Backlight DA/PWM	0xe5 "0" "1" "R" "r" "?"	Set backlight control method: PWM / DA Reset Query	"0" – PWM (Default) "1" – D/A
Backlight PWM frequency	0xe6, nnn "+" "-" "R" "r" "?"	Set backlight PWM frequency = value/increase 20Hz/decrease 20Hz Reset Query	Value 100Hz : "0", "6", "4" 120Hz : "0", "7", "8" 140Hz : "0", "8", "C" 160Hz : "0", "A", "0" (Default) 180Hz : "0", "B", "4" 200Hz : "0", "C", "8" 220Hz : "0", "D", "C" 240Hz : "0", "F", "0" 260Hz : "1", "0", "4" 280Hz : "1", "1", "8" 300Hz : "1", "2", "C" 320Hz : "1", "4", "0" 340Hz : "1", "5", "4" 360Hz : "1", "6", "8" 380Hz : "1", "7", "C" 400Hz : "1", "9", "0" 420Hz : "1", "A", "4" 440Hz : "1", "B", "8"
Backlight Invert	0xe7 "0" "1" "R" "r" "?"	Set invert backlight level : Off / On Reset Query	"0" – Off (Default) "1" – On
PIP window transparency Level	0xed, nn "+" "-" "R" "r" "?"	Select PIP transparency level = value/increase/decrease Reset Query	nn: 0x00~0x0A (no ~ total transparency) Default: 0x00
Set IR ID	"0xee", "0x5A" nn "+" "-" "R" "r" "?"	Set IR ID Reset Query	IR ID 1~255 nn = "0" "1" ~ "46" "46" Reset ID is 0 nn = "30" "30"
Minimum backlight level	0xee, "0x5C" nn "+" "-" "R" "r" "?"	Set minimum backlight level= value/increment/decrement Reset Query	Minimum Backlight value. nn: 0x00 ~ 0x32 (0~50%) Default: 5%
OSD switch mount Lock	"0xee", "0x62" "0" "1" "?"	Unlock / Lock Query	"0"- Unlock (Default) "1"- Lock, no response to OSD switch mount keys
Default Power	"0xee", "0x6B", "0x50"	Default power state after supplying power to controller	

User EDID	"0xee", "0x76", "nn",	Command Select Port	"nn" = "0x41,0x31" A0: VGA "0x50, 0x31" D0: DP "0x48,0x31" D1: HDMI "0x48,0x32" D2: HDMI "0x48,0x33" D3: HDMI "0x45,0x31" D3: HD-SDI (custom code) "0x46,0x31" D4: DVI
EDID Block map for blocks 0 – 128	"S" "s" "n,n+1....(256 BYTE) "	Send 128 BYTE EDID in ASCII Code Format (256BYTE)	return "1" Success return "0" Fail
EDID Block map for blocks 129 – 254 if more than 128 blocks used	"E" "e" "n,n+1....(256 BYTE) "	Send 128 BYTE EDID in ASCII Code Format (256BYTE)	return "1" Success return "0" Fail
Reset	"R" "r"	Reset to use pre-defined EDID instead of user EDID of selected port	return "1" Success return "0" Fail

3. Other control

Function	Command	Description	Acknowledge (if enabled)
Select RS-232 acknowledge	0xc1, "0" "1"	Disable/enable command acknowledge.	"0" – acknowledge disabled. "1" – acknowledge enabled. (Default)
VGA auto adjust	0xc3	Start VGA auto adjust	"0" – fail. "1" – successful.
Command availability	0xc4, nn / nnnn	Check whether a command is available.	"0" – not available. "1" – available. e.g "0x81" command send "0xc4 0x38 0x31" feedback "0xc4 0x38 0x31 0x31" e.g "0xee 0x5c" command send "0xc4 0x45 0x45 0x35 0x43" feedback "0xc4 0x45 0x45 0x35 0x43 0x31"
VGA auto color gain	0xc5	Start VGA auto-calibration of gain of the RGB amplifier.	"0" – fail. "1" – successful.
Power On/Off	0xc8, "0" "1" "?"	Soft power on/off off/on query	"0" – soft power off. "1" – soft power on.
Query video input status	0xc9	Query the status of the displaying video windows source	Input status nn nn: "0", "0" : no video source / disabled "A", "1" A0: VGA "F", "1" D4: DVI "H", "1" D1: HDMI "H", "2" D2: HDMI "H", "3" D3: HDMI "E", "1" D3: HD-SDI (for custom code) "P", "1" D0: DP Feedback 4 video windows status in form of: nn nn, nn nn, nn nn, nn nn (P1, P2, P3, P4)
Query BIOS version	0xcb, "0"	Read BIOS version	BIOS version "VV.YY.ZZ" VV = Vx or Ex, (x is version digit) V = Release version E = Engineering Sample YY= Version Number ZZ= Customer Number
Query PCBA number	0xcb, "1"	Read PCBA number	"nnnnn" = PCBA number SVX-4096-VW-120= "41759"
Query Revision Number	0xcb, "3"	Read Revision Number	"nn" = Revision number AA in firmware version no. "VV.YY.ZZ.AA"
Reset parameters	0xce	Reset all parameters to default value	"1" – successful.
Reset all parameters	0xcf	Reset all parameters, including user color temperature setting, for all video modes to default value	"1" - successful.

n = 1-byte ascii-coded hex number, e.g., parameter value of 0x1 is represented by "1" (0x31).
 mn or nn = 2-byte ascii-coded hex number, e.g., parameter value of 0x1e is represented by "1", "e" | "E" (0x31, 0x6e|0x4e).

The RS-232 command strings sent in one time can support up to 380 bytes via CN8 port
 The RS-232 command string sent in one time can support up to 50 bytes via CN1 or J1 port.

n = 1-byte ascii-coded hex number, e.g., parameter value of 0x1 is represented by "1" (0x31).
 mn or nn = 2-byte ascii-coded hex number, e.g., parameter value of 0x1e is represented by "1", "e" | "E" (0x31, 0x6e|0x4e).
 Please refer to the ASCII to Hex convert table below.

Hex to ASCII conversion table

Hex	ASCII	Hex	ASCII	Hex	ASCII	Hex	ASCII
0x30	0	0x41	A	0x61	a	0x2B	+
0x31	1	0x42	B	0x62	b	0x2D	-
0x32	2	0x43	C	0x63	c	0x3F	?
0x33	3	0x44	D	0x64	d		
0x34	4	0x45	E	0x65	e		
0x35	5	0x46	F	0x66	f		
0x36	6	0x47	G	0x67	g		
0x37	7	0x48	H	0x68	h		
0x38	8	0x49	I	0x69	i		
0x39	9	0x4A	J	0x6A	j		
		0x4B	K	0x6B	k		
		0x4C	L	0x6C	l		
		0x4D	M	0x6D	m		
		0x4E	N	0x6E	n		
		0x4F	O	0x6F	o		
		0x50	P	0x70	p		
		0x51	Q	0x71	q		
		0x52	R	0x72	r		
		0x53	S	0x73	s		
		0x54	T	0x74	t		
		0x55	U	0x75	u		
		0x56	V	0x76	v		
		0x57	W	0x77	w		
		0x58	X	0x78	x		
		0x59	Y	0x79	y		
		0x5A	Z	0x7A	z		

Appendix III – Mapping definition

Definition of division

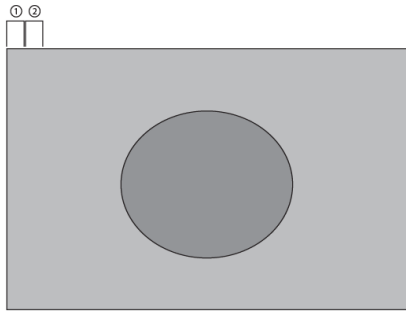

1 Division
(Non-Division)

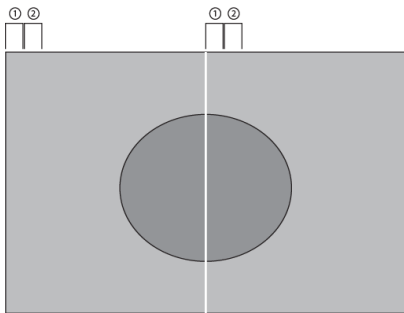

2 Division

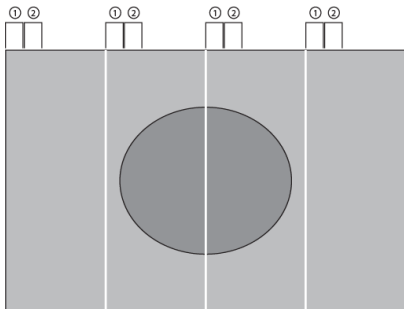

4 Division

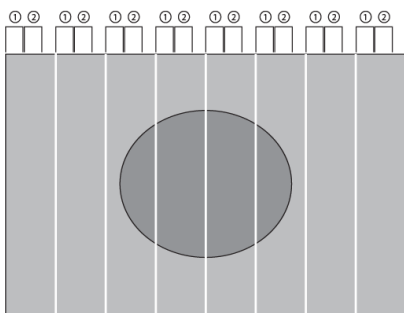

8 Division

Input data mapping

VESA Format (LVDS) (Mapping A)

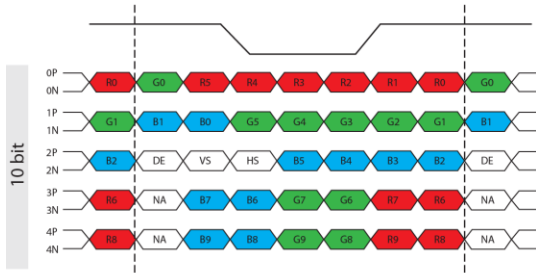

VESA Format (LVDS) (Mapping B)

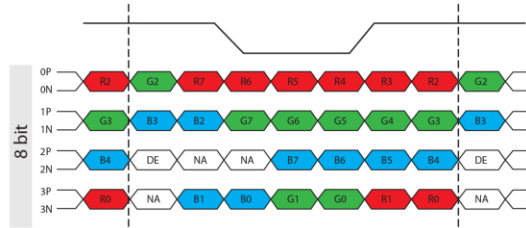

JEIDA Format (LVDS)

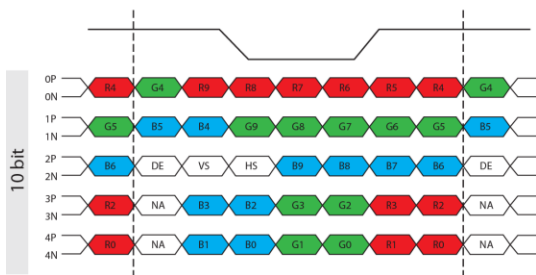

Appendix IV – DV remote control unit work for SVX-4096-VW

P/N 559000106-3 :
DigitalView remote control unit
(without DV logo silk screen
printing)

P/N 559000105-3 :
DigitalView remote control unit
(with DigitalView logo silk screen
printing)



BUTTON	FUNCTION
POWER BUTTON	Soft power ON/OFF button.
SEL UP (^) / SEL DN (v)	1. In OSD menu, pressing "SEL UP" button to move previous level of selection. 2. In OSD menu, pressing "SEL DN" button to move next level of selection or to CONFIRM the selection.
+ BUTTON	1. When OSD menu displayed, press this button to select functions (forward) or increase the values.
- BUTTON	1. When OSD menu displayed, press this button to select functions (backward) or decrease the values.
AV/TV	1. Show input source selection menu.
OSD NEXT BUTTON	1. Use to turn on/off the OSD menu.
Mute	1. Mute / Un-mute audio (if external audio board is connected)
PIP	1. Toggle between PIP mode and 1P mode.

Appendix V – Functions list on browser page

Below is a summary of functions list on IP-60's browser page.

Main

Network

Network Configure

Firmware Version	
MAC Address	
Host Name	
DHCP	On / Off
IP Address	
Subnet Mask Address	
Default Gateway Address	
Primary DNS Address	

Sensor Setting

Fan Setting

Fan 1	On / Off
Fan 2	On / Off
Fan 1 min rpm	
Fan 2 min rpm	

Light Sensor Setting

Light Sensor	On / Off
Min. Value	

Power Detect Setting

Power Source 1 (PS1)	On / Off
Power Source 2 (PS2)	On / Off
PS1 Value	
PS2 Value	

Temperature Setting

Internal Temp. Sensor	On / Off
External Temp. Sensor	On / Off
Int. Temp. Warning Value	Value
Ext. Temp. Warning Value	Value

Monitor Status

Fans Monitor (Fan 1)	
Fans Monitor (Fan 2)	
Temperture Monitor (Int. Temp.)	
Temperture Monitor (Ext. Temp.)	
Power Monitor (PS 1)	
Power Monitor (PS 2)	
Light Monitor (Light1)	

Direct Control

Picture Setting

Brightness	Value
Contrast	Value
Saturation	Value
Sharpness	Value
Hue	Value

Backlight Control

Soft Power	On / Off
Backlight Status	On / Off
Backlight Control	Value
Backlight PWM Frequency	PWM (100Hz-440Hz)

Display Mode

1P / 2P_LR / 2P_TB / 2P_PIP / 4P

Input Source Selection

P1 Input Source	Display Port/HDMI 1/HDMI 2/DVI/VGA
P2 Input Source	Display Port/HDMI 1/HDMI 2/DVI/VGA
P3 Input Source	Display Port/HDMI 1/HDMI 2/DVI/VGA
P4 Input Source	Display Port/HDMI 1/HDMI 2/DVI/VGA

Check Input Status

Check Main & PIP Source	Invalid/ARGB/HD/SD Component/DVI/HDMI/Display Port
-------------------------	----------------------------------------------------

Audio Setting

Mute	On / Off
Volume	Value
Source Selection	P1/P2/P3/P4/Analog

Color Setting

Color Temperature	3200K/5800K/6500K/7500K/9300K/sRGB/User
User - Red Level Color Temp.	Value
User - Green Level Color Temp.	Value
User - Blue Level Color Temp.	Value
Color Effect	Standard/Game/Movie/Photo/Vivid/User
Gamma	Off/1.8/2.0/2.2/2.4

Advanced Setting

Aspect Ratio	Full/16:9/4:3/5:4/1:1
Display Orientation	Normal/Anti-Clockwise 90/Rotate 180/Anti-Clockwise 270

PIP Setting

Swap	
PIP Size	(0 - 10)
PIP Horizontal Position	Value
PIP Vertical Position	Value

OSD Setting

OSD Status	On / Off
OSD Turn	On / Off
OSD Horizontal Position	Value
OSD Vertical Position	Value
OSD Menu Timeout	Value

Key Control

Menu/Down/Up/Left(-)/Right(+)

Display Information

BIOS Version
Horizontal Resolution
Vertical Resolution
Horizontal Frequency
Vertical Frequency

Load Default

Reset All Parameters	Reset all parameters to default value
Reset Parameters	Reset all parameters for all video mode to default value

WARRANTY

The products are warranted against defects in workmanship and material for a period of three (3) year from the date of purchase provided no modifications are made to it and it is operated under normal conditions and in compliance with the instruction manual.

The warranty does not apply to:

- Product that has been installed incorrectly, this specifically includes but is not limited to cases where electrical short circuit is caused.
- Product that has been altered or repaired except by the manufacturer (or with the manufacturer's consent).
- Product that has subjected to misuse, accidents, abuse, negligence or unusual stress whether physical or electrical.
- Ordinary wear and tear.

Except for the above express warranties, the manufacturer disclaims all warranties on products furnished hereunder, including all implied warranties of merchantability and fitness for a particular application or purpose. The stated express warranties are in lieu of all obligations or liabilities on the part of the manufacturer for damages, including but not limited to special, indirect consequential damages arising out of or in connection with the use of or performance of the products.

CAUTION

Whilst care has been taken to provide as much detail as possible for use of this product it cannot be relied upon as an exhaustive source of information. This product is for use by suitably qualified persons who understand the nature of the work they are doing and are able to take suitable precautions and design and produce a product that is safe and meets regulatory requirements.

LIMITATION OF LIABILITY

The manufacturer's liability for damages to customer or others resulting from the use of any product supplied hereunder shall in no event exceed the purchase price of said product.

TRADEMARKS

The following are trademarks of Digital View Ltd:

- Digital View
- SVX-4096-VW

CONTACT DETAILS

Digital View has offices in Asia, Europe and USA :

USA

Digital View Inc.
18440 Technology Drive
Building 130
Morgan Hill,
California, 95037
USA

Tel: (1) 408-782 7773 **Fax:** (1) 408-782 7883

Sales: ussales@digitalview.com

EUROPE

Digital View Ltd.
The Lake House
Knebworth Park
Herts, SG3 6PY
UK

Tel: +44-(0)20-7631-2150 **Fax:** +44-(0)20-7631-2156

Sales: uksales@digitalview.com

ASIA

Digital View Ltd
705-708, 7/F Texwood Plaza
6 How Ming St.
Kwun Tong
Hong Kong

Tel: (852) 2861 3615 **Fax:** (852) 2520 2987

Sales: hksales@digitalview.com

WEBSITE

www.digitalview.com

Revision History

Date	Rev No.	Page	Summary
24 August 2017	1.0	All	First issued.