

Application Note: Rename port name
for SVX-4096



Version: 1.00

Date: 17 Feb 2021

Application Note

Rename port name feature for SVX-4096 P/N 4175500XX-3

Application Note: Rename port name
 for SVX-4096



Version: 1.00

Date: 17 Feb 2021

Revision History

Date	Rev No.	Page	Summary
17 Feb 2021	1.00	All	First issued

Application Note: Rename port name for SVX-4096



Version: 1.00

Date: 17 Feb 2021

Content:

(1) Setup	4
(2) Install the TCP/IP Serial Utility Program	5
(3) Rename the port name displayed on OSD menu	6
(4) RS-232 commands for rename port name feature	9
(5) Contact Details	10

Application Note: Rename port name for SVX-4096



Version: 1.00

Date: 17 Feb 2021

(1) Setup :

This application note will show how to rename the port name displayed on the OSD menu on the SVX-4096 controller.

Please make sure you have the following materials before starting the work :

1) The target LCD panel

2) The target SVX-4096 LCD controller board:

- Use firmware version E1.07.00.22 or up for the SVX-4096.

3) P/IP Serial Utility program version 1.11 (available from the Digital View website Accessories / Software page: www.digitalview.com/accessories/software.html)

4) PC with RS-232 / network port

5) PC with Microsoft Windows 7 or later.

6) RS-232 programming cable (e.g P/N 426090100-3) or network cable.

If using RS-232, please connect CN8 socket to PC serial port (2400bps, 8N1), if using network, please make sure the internal network is working.

Use RS-232 programming cable (suggest to use P/N 426090100-3). DB9 connector connect to serial port, and Molex 51021-0600 / JST XHP-6 or compatible connect to CN8 on the controller board.

For RS-232 cable drawing P/N 426171800-3 :

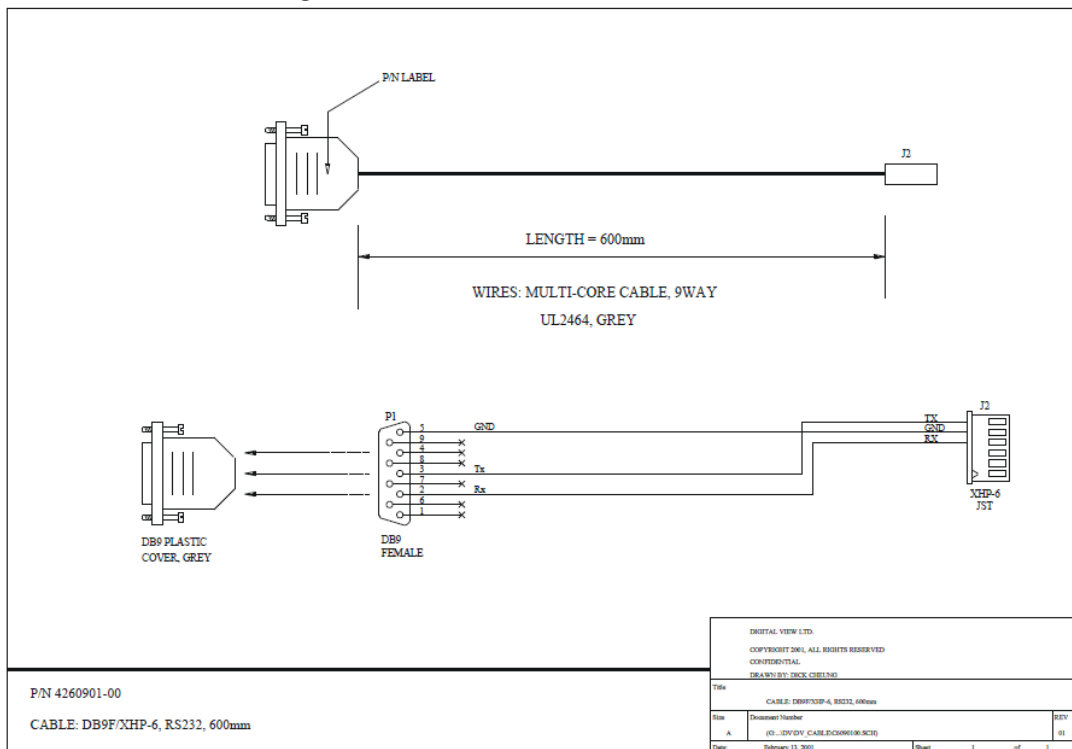

Application Note: Rename port name for SVX-4096



Version: 1.00

Date: 17 Feb 2021

(2) Install the TCP/IP Serial Utility Program

Step 1: Install the TCP/IP Serial Utility program (Version 1.11 or later). (Please uninstall any earlier versions before installing the latest version)



Step 2: Open the TCP/IP Serial Utility Program

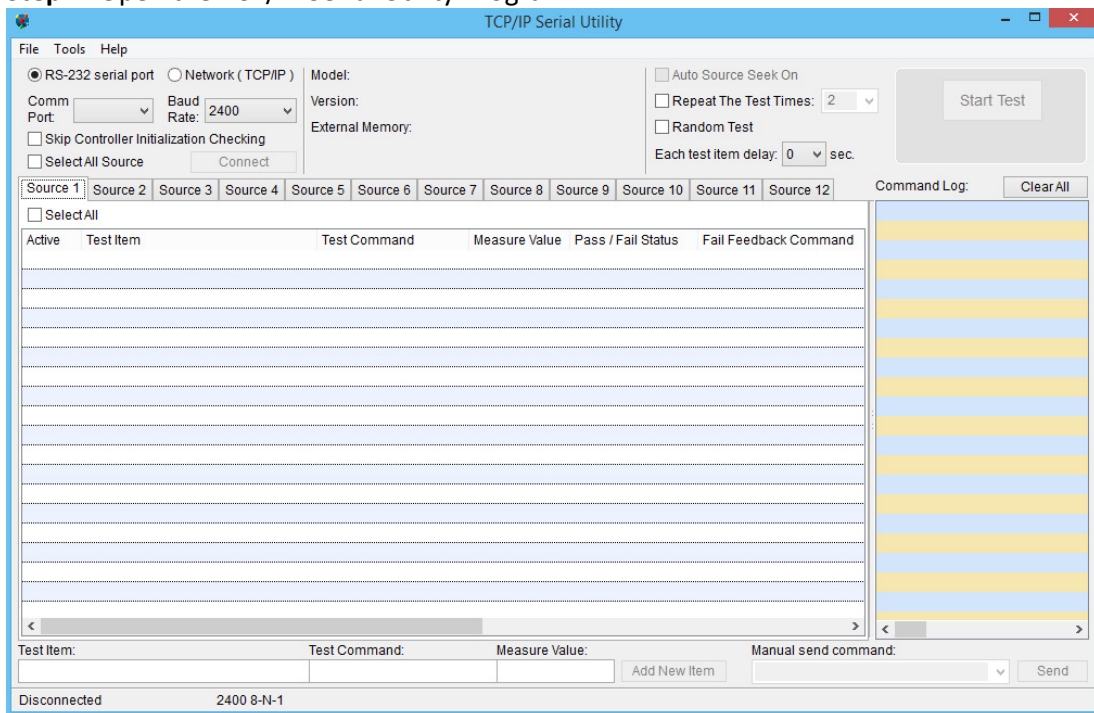

Application Note: Rename port name for SVX-4096

Version: 1.00

Date: 17 Feb 2021

(3) Rename the port name display on OSD menu

Step 1:

> Use RS-232 serial port :

Select 'RS-232' under OSD menu location > Advanced > Communication > RS-232 :

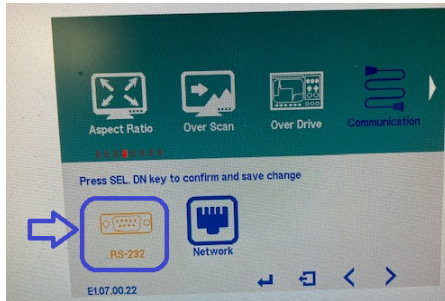

Choose the communication port (RS-232 serial port) in TCP/IP Serial Utility Program and select corresponding "Baud Rate" (2400) matching with the controller. Then Click **Connect**.

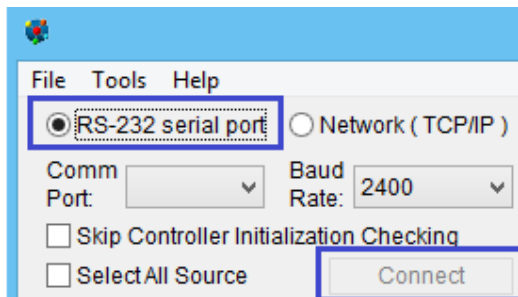

OR :

Application Note: Rename port name for SVX-4096

Version: 1.00

Date: 17 Feb 2021

> Use Network (TCP/IP) :

Select 'Network' under OSD menu location > Advanced > Communication > Network :

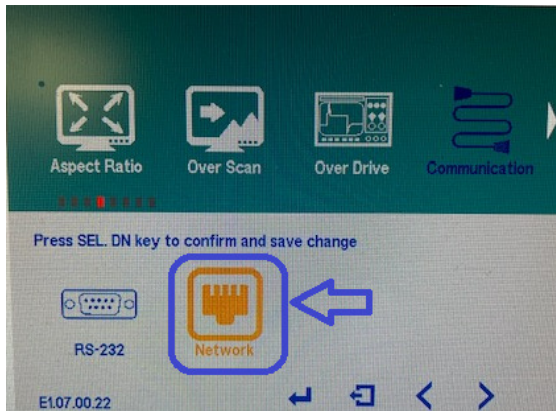

Choose the communication port (Network (TCP/IP)) in TCP/IP Serial Utility Program and select corresponding IP address for the controller you want to control. Then Click **Connect**.

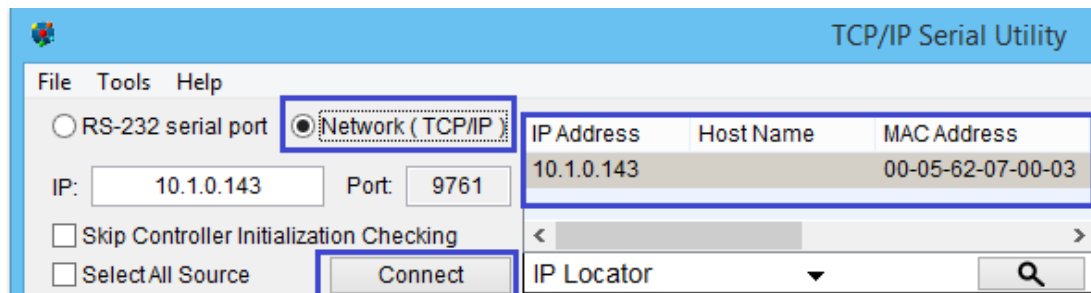

If the connection is successful, it should show the SVX-4096 version :

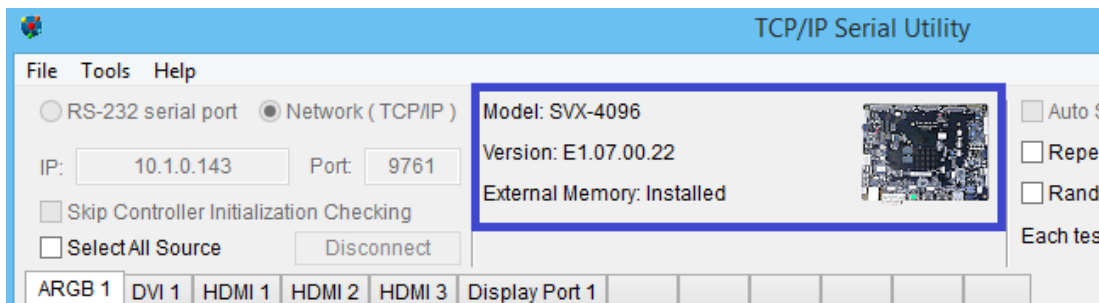

Application Note: Rename port name for SVX-4096

Version: 1.00

Date: 17 Feb 2021

Step 2: Choose 'Port Naming' under 'Tools' in the TCP/IP Serial Utility Program.

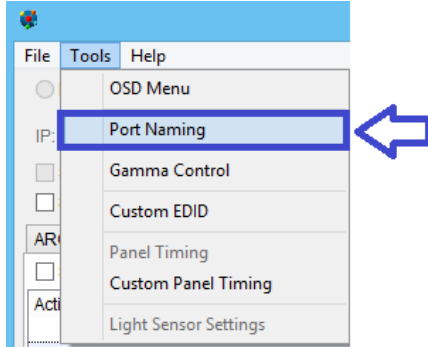

Input the port names (Maximum 11 Characters) to be changed and click 'Change'.

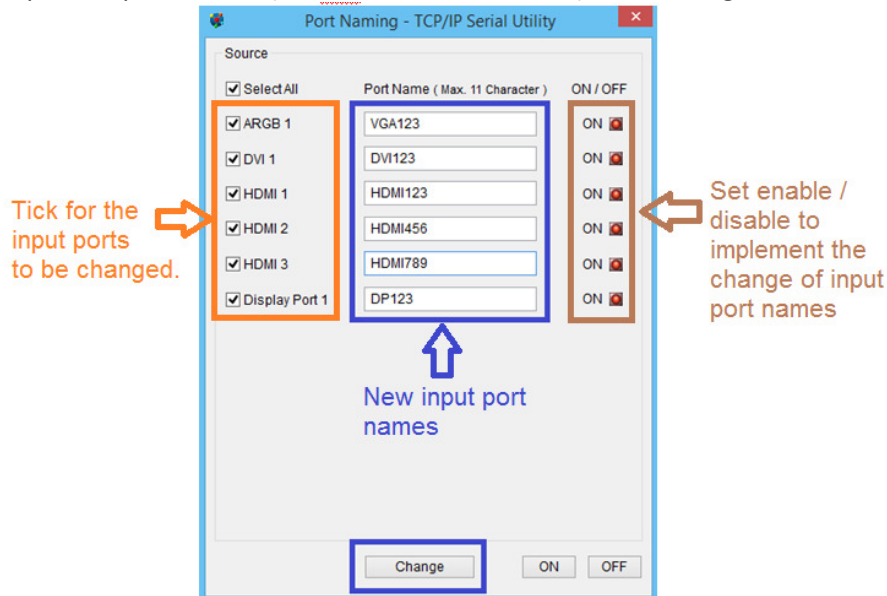

The port names are renamed and displayed on the OSD menu shown below :

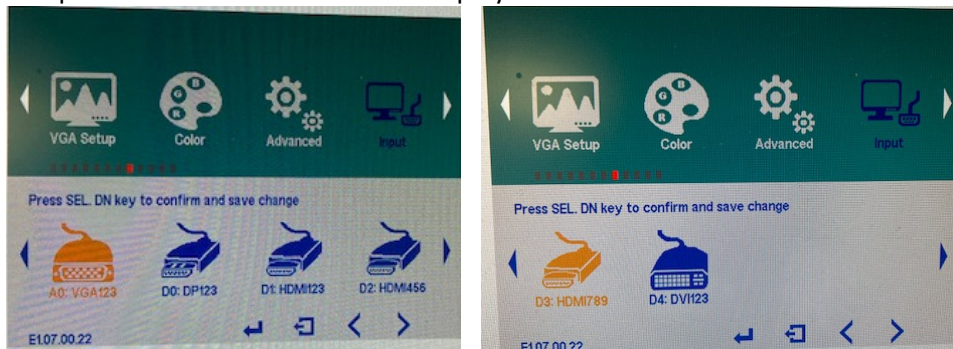

Application Note: Rename port name for SVX-4096



Version: 1.00

Date: 17 Feb 2021

(4) RS-232 commands for rename port name feature :

<p>User Port Naming ON/OFF (E1.07.00.21 or later)</p>	<p>“0xee”, “0x6D”, “0x41” “nn” “1” “0” “?”</p>	<p>Command Select Port On Off Query</p>	<p>“nn” = “0x41,0x31”- ARGB “0x46,0x31”- DVI “0x48,0x31” HDMI “0x48,0x32” HDMI “0x48,0x33” HDMI “0x50,0x31” DP</p>
<p>Read / Write User Port Naming (E1.07.00.21 or later)</p>	<p>“0xee”, “0x6D”, “0x42” “nn” “R” “r” “W” “w” “{” xxxxxxxxxx “}”</p>	<p>Command Select Port Read Write Start for Naming String Max 11 Char. End for Naming String</p>	<p>“nn” = “0x41,0x31”- ARGB “0x46,0x31”- DVI “0x48,0x31” - HDMI “0x48,0x32” - HDMI “0x48,0x33” - HDMI “0x50,0x31” - DP Support ASCII Table “0x20 ~0x7f” but not include “{“0x7b and “}” 0x7d</p>
<p>e.g Write 1 Send Code: 0xEE 0x6D 0x42 0x48 0x31 0x57 0x7B 0x30 0x31 0x32 0x7D Return Code:0xEE 0x6D 0x42 0x48 0x31 0x57 0x7B 0x30 0x31 0x33 0x7D 0x7B 0x30 0x31 0x32 0x7D 0x31 e.g Write 2 Send Code: 0xEE 0x6D 0x42 0x48 0x31 0x57 0x7B 0x48 0x64 0x6D 0x69 0x7D Return Code:0xEE 0x6D 0x42 0x48 0x31 0x57 0x7B 0x48 0x64 0x6D 0x69 0x7D 0x7B 0x48 0x64 0x6D 0x69 0x7D 0x31 e.g Read Send Code: 0xEE 0x6D 0x42 0x48 0x31 0x52 Return Code:0xEE 0x6D 0x42 0x48 0x31 0x52 0x7B 0x48 0x64 0x6D 0x69 0x7D</p>			

Application Note: Rename port name for SVX-4096



Version: 1.00

Date: 17 Feb 2021

(5) CONTACT DETAILS

- USA:** Digital View Inc.
18440 Technology Drive
Building 130
Morgan Hill, CA 95037
Tel: (1) 408-782 7773 **Fax:** (1) 408-782 7883
Sales: ussales@digitalview.com
- EUROPE:** Digital View Ltd.
The Lake House
Knebworth Park
Herts, SG3 6PY
UK
Tel: (44) (0)20 7631 2150 **Fax :** (44) (0)20 7631 2156
Sales : uksales@digitalview.com
- ASIA:** Digital View Ltd.
Unit 705-708, 7/F Texwood Plaza
6 How Ming Street
Kwun Tong
Hong Kong.
Tel: (852) 28613615 **Fax:** (852) 25202987
Sales: hksales@digitalview.com

Specifications subject to change without notice

appnote - rename port name for SVX-4096 (Feb 2021)

© Digital View Ltd 2021