



PC, DVI & VIDEO INTERFACE CONTROLLER FOR TFT & PLASMA PANEL

Model: DVI-1600

Part number : 4168800-XX

INSTRUCTIONS

CONTENTS

- Page: **2. Introduction, How to Proceed, Usage Note, Disclaimer**
3. System design – Diagram of a suggested system
4. Assembly notes – Important information about system elements
6. Connection & Operation – How to use the controller
12. Connectors, pinouts & jumpers – Essential connection information
20. Controller dimensions
21. Application notes
25. Troubleshooting
26. Specifications
27. Appendix I – RS-232 command protocol
33. Appendix II – Supported modes table
35. Warranty, Caution & Limitation of Liability, Trademarks
36. Contact details

It is essential that these instructions are read and understood before connecting or powering up this controller.

Introduction

The DVI-1600 is an enhanced version of SV-1600 controller by equipped with DVI-D input support additionally. The controller provides an auto-input synchronization and easy to use interface controller for:

- TFT (active matrix) LCD panels of 1600x1200, 1366x768, 1280x1024, 1280x768, 1280x600, 1024x768, 800x600 and 640x480 resolutions.
- Plasma panels of 852x480, 1024x1024 and 1365x768 resolutions.
- Computer video signals of VGA, SVGA, XGA, SXGA and UXGA standard.
- Video signals of NTSC, PAL and SECAM standard.
- Two sets of video input (Primary and Secondary) are available.
- DVI-D input support up to UXGA 60Hz input signals
- Volume control of audio (optional add-on board required)

HOW TO PROCEED

- Ensure you have all parts & that they are correct, refer to:
 - Connection diagram (separate document for each panel)
 - Connector reference (in following section)
 - Assembly notes
- Check controller switch & jumper settings (errors may damage the panel)
- Prepare the PC
- Connect the parts
- Understand the operation & functions

IMPORTANT USAGE NOTE

This equipment is for use by developers and integrators, the manufacturer accepts no liability for damage or injury caused by the use of this product. It is the responsibility of the developer, integrators or other user of this product to:

- Ensure that all necessary and appropriate safety measures are taken.
- Obtain suitable regulatory approvals as may be required.
- **Check power settings to all component parts before connection.**
- **When the first time connect to Plasma panel, it is recommended to perform "Load Factory Defaults" in order to get the right GAMMA setting :**

For TFT LCD connect, suggested GAMMA setting is "1.0"

For Plasma panel connect, suggested GAMMA setting is "2.2"

DISCLAIMER

There is no implied or expressed warranty regarding this material.

SYSTEM DESIGN

A typical LCD based display system utilising this controller is likely to comprise the following:

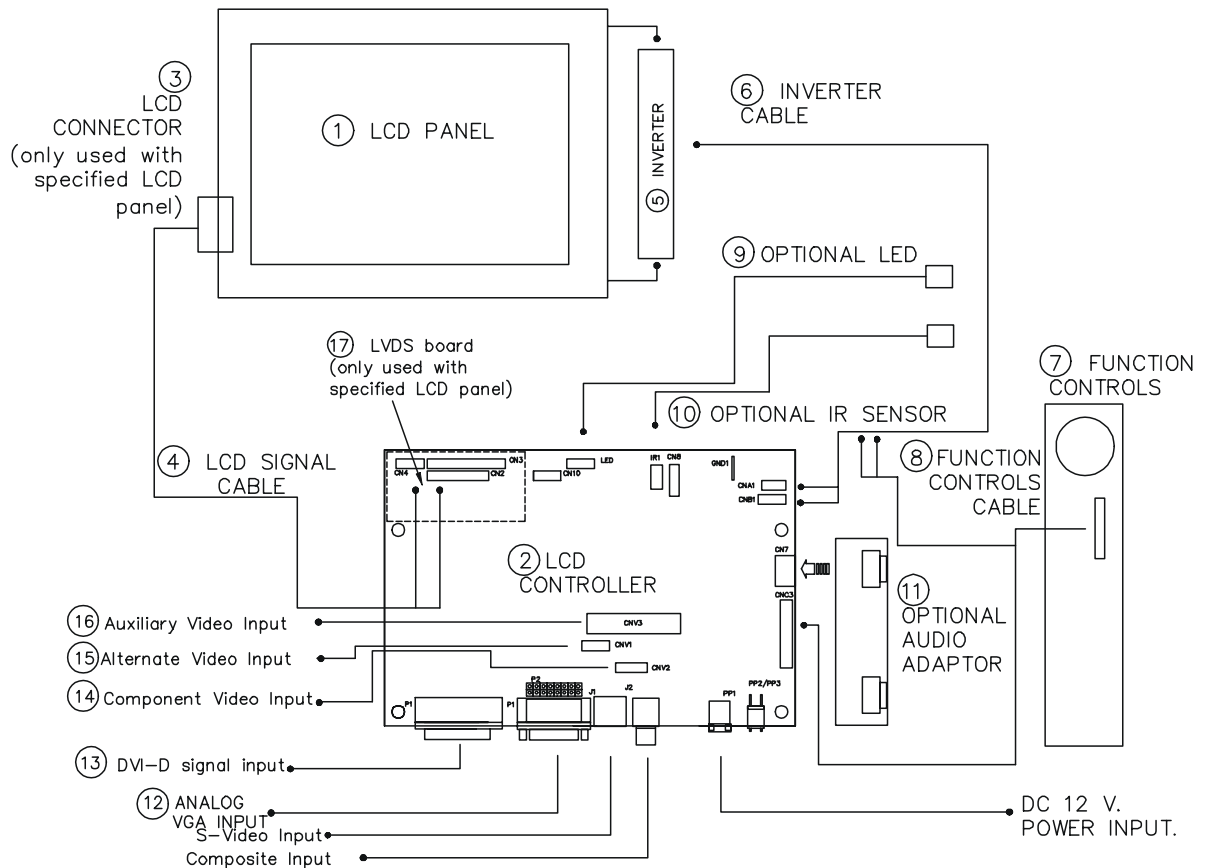

Summary:

1. LCD panel
2. LCD controller card, DVI-1600
3. LCD panel connector board for LCD signal cable (if necessary)
4. LCD signal cables
5. Inverter for backlight (if not built into LCD)
6. Inverter cable
7. Function controls
8. Function controls cable
9. Status LED (optional)
10. IR sensor (optional)
11. Audio add-on board (optional)
12. External type signal inputs
 - Analog VGA cable
 - AV cables (J1: S-video, J2: Composite video)
13. DVI-D signal input
14. Component video input
15. Alternate video input
16. Auxiliary video input
17. LVDS board (only used for specified LCD panel)

Digital View provides a range of parts, such as listed above, to make up complete display solutions.

ASSEMBLY NOTES

This controller is designed for monitor and custom display projects using 1600x1280 or 1366x768 or 1280 x 1024 or 1280x768 or 1280x600 or 1024 x 768 or 800x600 or 640x480 resolution TFT panels with a VGA, SVGA, WXGA, WSVGA, XGA, SXGA or UXGA signal input. The following provides some guidelines for installation and preparation of a finished display solution.

Preparation: Before proceeding it is important to familiarize yourself with the parts making up the system and the various connectors, mounting holes and general layout of the controller. As much as possible connectors have been labeled. Guides to connectors and mounting holes are shown in the following relevant sections.

1. **LCD Panel:** This controller is for TFT panels with 3.3V, 5V or 12V TTL or LVDS/TMDS interface. For LVDS/TMDS a separate add-on board is required. Due to the variation between manufacturers panels signal timing and other panel characteristics, factory setup and confirmation should be obtained before connecting to a panel. **(NOTE: Check panel power jumper settings before connection)**
2. **Controller:** Handle the controller with care as static charge may damage electronic components. Make sure correct jumper and dip switches settings to match the target LCD panel.
3. **LCD connector board:** Different makes and models of LCD panel require different panel signal connectors and different pin assignments.
WIRING NOTE: If panels of less than 3 x 8 bit are used, e.g. 3 x 6 bit, then connection of panel signal high value should correspond to the controllers highest bit. For example for a 6 bit panel R5 (Red data bit) on the panel should connect to R7 on the controller, in this case R1 & R0 on the controller will not be connected. Same for Green & Blue.
4. **LCD signal cables:** In order to provide a clean signal it is recommended that LCD signal cables should not longer than 33cm (13 inches). If loose wire cabling is utilised these can be made into a harness with cable ties. Care should be taken when placing the cables to avoid signal interference. Additionally it may be necessary in some systems to add ferrite cores to the cables to minimise signal noise.
5. **Inverter:** This will be required for the backlight of an LCD, some LCD panels have an inverter built in. As LCD panels may have 1 or more backlight tubes and the power requirements for different panel backlights may vary it is important to match the inverter in order to obtain optimum performance. See Application notes for more information on connection.
6. **Inverter Cables:** Different inverter models require different cables and different pin assignment. Make sure correct cable pin out to match inverter. Using wrong cable pin out may damage the inverter.
7. **Function Controls:** The following section discusses the controls required and the section on connectors provides the detail. The controls are minimal: On/Off, Backlight Brightness (depends on inverter), OSD (5 momentary buttons) analog VR type or (8 momentary buttons) digital type.
8. **Function controls cable:** The cables to the function switches should be of suitable quality and length so that impedance does not affect performance. Generally lengths up to 1 meter (3 feet) should be acceptable. Please refer to page 22-23 for the connection of the function control cable to the inverter cable for controlling the backlight brightness.
9. **Status LED:** The pin direction of the LED should be corrected for right colour indication. Red colour stands for standby. Green colours stands for signal on. The status LED is an optional part only, can be unconnected.
10. **IR sensor:** It is an optional part only, can be unconnected if not using IR remote control.
11. **Audio add-on board:** With the optional audio add-on board it is possible to control volume through the OSD menu. The audio board fits on the right hand edge of the main controller.
12. **VGA Input Cable:** As this may affect regulatory emission test results and the quality of the signal to the controller a suitably shielded cable should be utilized.
 - **AV cables:** Standard Composite or S-video cables can be used. Reasonable quality cable should be used to avoid image quality degradation.
 - **Power Input:** 12V DC is required, this should be a regulated supply. The power rating is depending on the panel and inverter used. Normally, power supply with 3.5Amp current output should enough for most of 4x CCFT panels. Although the controller provides power regulation for the LCD power this does not relate to the power supplied to the backlight inverter. If an unregulated power supply is provided to an inverter any fluctuations in power may affect operation, performance and lifetime of the inverter and or backlight tubes.
 - **Power output:** Note the controller has an overall 3Amp current limit and the current available from the auxiliary power output will be dependent on the power input and other system requirements.
 - **Power Safety:** Note that although only 12VDC is required as 'power-in' a backlight inverter for panel backlighting produces significantly higher voltages (the inverter does not connect to the ground plane). We strongly advise appropriate insulation for all circuitry.
13. **DVI-D Input Cable :** Plug the DVI cable to the connector P3 on the controller board. DigitalView offers the DVI-D to DVI-D cable P/N 4262102-00 for connection
14. **Component video input :** Plug the component video input cable to the connector CNV2 on the controller board.

- 15 Alternative video input :** This input is the alternative port for J1 – S-Video and J2 – Composite Video.
- 16 Auxiliary video input :** This input is offer the primary and secondary video input port together into CNV3 connector. It can be switched between these two ports (Port 1 - Primary and Port 2 - Secondary) by OSD menu. DigitalView offers this cable P/N 4260006-00 for connection.
- 17 LVDS board (only used for specified LCD panel) :** LVDS board is necessary to plug on the controller board for LVDS panels connection. Please refer the corresponding connection diagrams for choosing the LVDS boards.
- **EMI:** Shielding will be required for passing certain regulatory emissions tests. Also the choice of external Controller to PC signal cable can affect the result.
 - **Ground:** The various PCB mounting holes are connected to the ground plane.
 - **Servicing:** The board is not user serviceable or repairable. Warranty does not cover user error in connecting up to the controller and is invalidated by unauthorized modification or repairs.
 - **Controller Mounting:** It is recommended that a clearance of at least 10mm is provided above and 5mm below the controller when mounted. Additionally consideration should be given to:
 - Electrical insulation.
 - Grounding.
 - EMI shielding.
 - Cable management. Note: It is important to keep panel signal cables apart from the inverter & backlight cables to prevent signal interference.
 - Heat & Ventilation: Heat generated from other sources, for example the backlight of a very high brightness panel may generate significant heat which could adversely affect the controller.
 - Other issues that may affect safety or performance.
 - **Touch Panels:** Support for touch panels or other low power consumption accessories is available by:
 - Connector CNA1 provides 5V & 12V DC which can be used to power such accessories.
 - **PC Graphics Output:** A few guidelines:
 - Signal quality is very important, if there is noise or instability in the PC graphics output this may result in visible noise on the display.
 - Refer to graphics modes table in specifications section for supported modes.
 - Non-interlaced & interlaced video input is acceptable.

IMPORTANT: Please read the Application Notes section for more information.

CONNECTION & OPERATION

CAUTION: Never connect or disconnect parts of the display system when the system is powered up as this may cause serious damage.

CONNECTION

Connection and usage is quite straight forward (it is useful to have the relevant connection diagram available at this time):

1. **LCD panel & Inverter:** Connect the inverter (if it is not built-in the panel) to the CCFT lead connector of the LCD panel.
2. **TTL type panels:** Plug the signal cables direct to CN2, CN3 and CN4 (CN4 will not be used for 3x6-bit panel) on the controller board. Plug the other end of cables to the LCD connector board (if connector board is required, otherwise the signal can be direct plug to the LCD panel connector). Then plug the board connector to the LCD panel connector.
LVDS/PanelLink type panels: A LVDS/PanelLink transmitter board is required. Plug the transmitter board to CN2, CN3 & CN4. Then insert the LCD signal cable with controller end to the connector on the transmitter board. Insert the panel end of the cable the LCD panel connector.
3. **Inverter & Controller:** Plug the inverter cable to CNB1 and CNA1 (if necessary). Plug another end to the connector on the inverter.
4. **Function switch & Controller:** Plug the OSD switch mount cable to CNC1 on the controller board and another to the OSD switch mount. And connect the BVR_WIP and BVR_A pins to the inverter cable. Please refer to page 22-23 for the connection of the function control cable.
5. **LED & Controller:** Plug in a 3-way with dual colour LED to connector LED1 on the controller board.
6. **IR & Controller:** Plug in a 3-way with IR sensor to connector IR1 on the controller board.
7. **Jumpers & Switches:** Check all jumpers and switches (SW1) are set correctly. Details referring the connection diagram (a separate document) or the jumpers and switches setting table (in the following section).
8. **Jumpers & Inverter & Panel voltage:** Particularly pay attention to the settings of JA3, JA5, JB2 and JB3. JB2 & JB3 are used for inverter control (read inverter specification and information on the jumper table to define the correct settings). JA3 & JA5 are used for panel voltage input (read panel specification and information on the jumper table to define the correct settings).
9. **VGA cable & Controller:** Plug the VGA cable to the connector P1 on the controller board.
10. **DVI cable :** Plug the DVI cable to the connector P3 on the controller board.
11. **Power supply & Controller:** Plug the DC 12V power in to the connector PP1 or PP2/3.
12. **Power on:** Switch on the controller board and panel by using the OSD switch mount.

The red LED will light up when power on. The LED will change to green when VGA signal on.

General:

- If you are using supplied cables & accessories, ensure they are correct for the model of panel and controller.
- If you are making your own cables & connectors refer carefully to both the panel & inverter specifications and the section in this manual, "Connectors, Pinouts & Jumpers" to ensure the correct pin to pin wiring.

PC SETTINGS

The controller has been designed to take a very wide range of input signals however to optimize the PC's graphics performance we recommend choosing 60Hz vertical refresh rate – this will not cause screen flicker.

OPERATION

Once the system has been connected and switched on there are a number of functions available to adjust the display image as summarized in the following sections. The settings chosen will be saved for each mode independently.

LCD DISPLAY SYSTEM SETTINGS

NOTE: By way of explanation the following refers to a set of sample buttons that may be obtained as an option. In addition to power on/off and connection for backlight brightness the controller provides an On Screen Display of certain functions which are controlled by 5 momentary type buttons (analog VR type) or 8 momentary type buttons (digital type):

Controls	Analog VR type	Digital type
On/Off – turns controller board power on	VR toggle switch	On/Off button
Brightness – controls backlight brightness	Rotary VR	Brightness +/- buttons
Menu – turns OSD menu On or Off (it will auto time off)	Menu button	Menu button
Select down – moves the selector to the next function (down)	SEL DN	SEL DN
Select up – moves the selector to the previous function (up)	SEL UP	SEL UP
+ – increase the setting/confirm the select	+	+
- – decrease setting	-	-

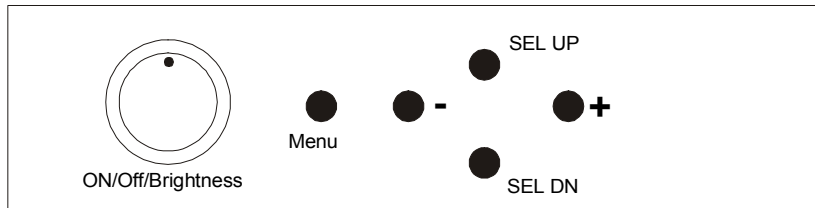



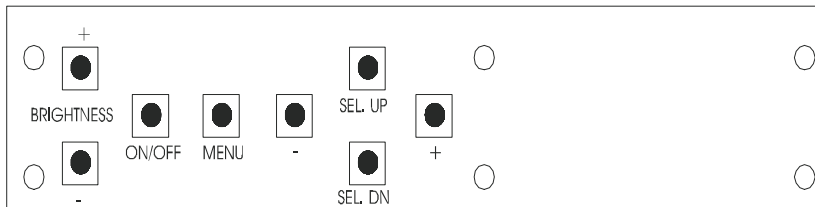



Analog VR type





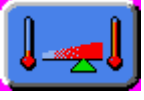





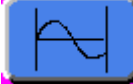













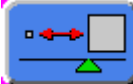

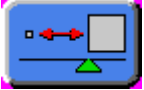
Digital type

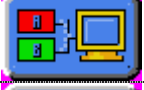

To turn on the OSD menu:	Press the MENU button
Move to next icon:	Press the MENU button
Select options within icon menu:	Use SEL UP/SEL DN buttons, the selected option is in yellow.
Increase/decrease setting:	Use +/- buttons
Move selection left/right:	Use +/- buttons, the selected option is in green
To confirm the selection:	Use + button

OSD functions

	<p>Brightness and Contrast :</p> <p>Brightness  Increase/decrease panel brightness level, total: 100 steps</p> <p>Contrast  Increase/decrease panel contrast level, total: 100 steps</p> <p style="text-align: right;">*No function in DVI mode</p>
	<p>Color Temperature : 9500K / 8000K / 6500K / 5000K</p> <p>Adjust the warmth of the image displayed. The higher temperature the coolest image looks like. The lower temperature the warmest image looks like.</p>
	<p>Video Adjustment : (DISPLAYED IN VIDEO MODE ONLY)</p> <p>Color:  adjust video color level</p> <p>Tint:  adjust video tint level</p> <p>Sharpness:  adjust video image sharpness level</p> <p>Picture Type : Motion / Still / Normal Select different modes for different videos: Motion mode – Good for sport and action movie film. Still mode – Steady and sharp image. For still picture displayed. Normal mode – “Non-flicker” image. For general movie film.</p> <p>Video Type: DVD / VCR Change brand width to match the source</p>

	<p>Frequency and Phase : (DISPLAYED IN PC & DVI MODE)</p> <p>Frequency  Adjust the image horizontal size</p> <p>Phase  Fine tune the data sampling position (adjust image quality)</p> <p>Picture Type : Motion / Still /Normal Select still mode to getting a stable still picture displayed inside PIP window. Select Normal mode to getting a better display quality for RGB video input</p> <p style="text-align: right;">*No function for frequency and phase adjustment in DVI mode</p>
	<p>Video System : Select video system and input signals (DISPLAYED IN VIDEO MODE ONLY)</p> <p>AUTO : automatic detection of NTSC and PAL system (not applicable in SECAM system)</p> <p>NTSC / NTSC 4.43 : manual select NTSC system</p> <p>PAL / PAL M : manual select PAL system</p> <p>SECAM : manual select SECAM system</p>
	<p>Status : (DISPLAYED IN PC & DVI MODE ONLY)</p> <p>Display graphic information: resolution and frequency</p>
	<p>Position :</p> <p>Image up/down : Use SEL UP/SEL DN to move the image vertically</p> <p>Image left/right : Use +/- to move the image horizontally</p> <p style="text-align: right;">*No function in DVI mode</p>
	<p>Rotation : (DISPLAYED IN VIDEO MODE ONLY)</p> <p>Rotates the image from landscape format to portrait format.</p>
	<p>Picture in Picture : (DISPLAYED IN PC & DVI MODE ONLY)</p> <p>PIP Size : Select PIP window size (from level 1 to level 24)</p> <p>PIP Source : Select video source to be display in PIP window:</p> <p>Auto – automatic detection of Composite, S-video and Component</p> <p>Composite – manual select composite video only</p> <p>SVideo – manual select S-video only</p> <p>YCbCr/RGB – manual select component video or RGB-composite sync*</p> <p style="text-align: center;">* Please refer to the SW2 Pos.#7 setting.</p> <p>Horizontal Position  adjust the position of the PIP window horizontally</p> <p>Vertical Position  adjust the position of the PIP window vertically</p> <p>Advanced PIP Settings :</p> <p>Brightness  adjust the image brightness of the PIP window</p> <p>Contrast  adjust the image contrast of the PIP window</p> <p>Sharpness  adjust the image sharpness of the PIP window</p> <p>Tint  adjust the tint of the image of the PIP window</p> <p>Color  adjust the color of the image of the PIP window</p>
	<p>Video Scaling : (DISPLAYED IN VIDEO MODE ONLY)</p> <p>Use the UP and DOWN arrow keys to select the following scaling modes.</p> <p>16:9 Normal (IN PLASMA DISPLAY MODE)</p> <p>16:9 Letterbox (IN PLASMA DISPLAY MODE)</p> <p>16:9 Letterbox with Subtitles (IN PLASMA DISPLAY MODE)</p> <p>4:3 Normal (IN PLASMA DISPLAY MODE)</p> <p>4:3 Letterbox (IN PLASMA DISPLAY MODE)</p> <p>4:3 Letterbox with Subtitles (IN PLASMA DISPLAY MODE)</p> <p>Normal</p> <p>Letterbox</p> <p>Letterbox with Subtitles</p> <p>Nonlinear Scaling Modes : Horiz Clipping / Horiz Offset / Horiz Stretch / Vert Clipping / Vert Offset / Vert Stretch</p>

	<p>Graphic Scaling Modes : (DISPLAYED IN PC & DVI MODE ONLY)</p> <p>Use the up and down arrow keys to choose a scaler mode. Use the + or - key to modify a following scaler parameters.</p> <p>One to One : Horizontal Pan  Vertical Pan </p> <p>Fill Screen : enable full screen expansion for lower resolution Image Fill to Aspect ratio : enable fill screen expansion for lower resolution image according to aspect ratio.</p> <p>Nonlinear Scaling Modes : Horiz Clipping / Horiz Offset / Horiz Stretch / Vert Clipping / Vert Offset / Vert Stretch</p>
	<p>Language : Select OSD menu language display</p> <ol style="list-style-type: none"> 1. English 2. Danish 3. Chinese (Simplified Chinese)
	<p>Video source : Select the input video signal</p> <p>Analog RGB / Component Video / Composite Video / S-Video /DVI</p>
	<p>Utilities :</p> <p>User Setting : Wide Screen Mode : 640x480 / 852 x 480 (IN PLASMA DISPLAY MODE) : Normal / Wide (IN WIDE SCREEN PANEL MODE)</p> <p>User Timeout : adjust the OSD menu timeout period in a step of 5 seconds (max 50 seconds)</p> <p>DPMS : Disable / Enable the DPMS function</p> <p>Display Input : Disable /Enable the input source name on screen</p> <p>Auto Source Select : Off - Disable auto source select function. Low - Auto source select enable ONLY in power up. High - Auto source select ALWAYS enable.</p> <p>Gamma : 1.0 1.6 2.2</p> <p>Video Port Select : Select "Port 1" or "Port 2" of the source Composite/SVideo/YCbCr</p> <p>OSD Setting : OSD Horz Position :  move the OSD menu horizontally OSD Vert Position :  move the OSD menu vertically OSD Background : Translucent / Opaque OSD Rotate : Normal / Rotate</p> <p>Freeze : Freeze the image (use "+" button)</p> <p>Zoom : Zoom level : enable the zoom in function on the image displayed. Use "+" button to zoom in the image. Use "-" button to decrease the zoomed image.</p> <p>Horizontal Pan :  Vertical Pan : </p> <p>Direct Access #1: Define the hot key function ("+" and "-") for one of the following Adjustments : Brightness / Contrast / Volume / Freeze / Zoom / Video Source* / PIP</p> <p>Direct Access #2: Define the hot key function ("SEL UP" and "SEL DN") for one of the following Adjustments : Brightness / Contrast / Volume / Freeze / Zoom / Video Source* / PIP</p> <p>Display Orientation : Normal / Horizontal Inverse / Vertical Inverse / Inverse</p> <p>Calibrate RGB Gain : Color Calibration (DISPLAYED IN PC MODE ONLY)</p> <p>Load Factory Defaults : Recall factory default settings.</p> <p>* By pressing the hot key, the source is in sequence of Analog RGB/Composite Video/S-Video/Component Video/DVI.</p>

	<p>Volume :</p>  <p>Adjust the audio volume level (functions only if the audio add-on installed)</p>
	<p>Exit menu</p>

(V1.60)

The OSD settings chosen will be stored in memory. The OSD menu can be cleared from the screen by moving the selection bar to the EXIT icon pressing the + button otherwise it will automatically clear after a few seconds (time-out period) of non-use.

RS-232 Serial control (Baud rate 2400 bps)

Physical connection :

Controller side
 Connector interface : CN8
 Mating connector : JST XHP-6

Computer side
 Connector interface : Serial port
 Mating connector : DB9 Female

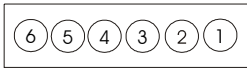

Mating face of CN8

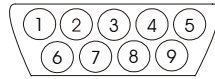

Mating face of RS-232 DB9 Male

PIN#	Description
4	RS-232 Tx Data
5	Ground
6	RS-232 Rx Data

PIN#	Description
2	RS-232 Rx Data
3	RS-232 Tx Data
5	Ground

Remark :

(1) : RS-232 connection cable, 600mm P/N 4260902-00 can be ordered separately for connection.

Software connection :

The OSD function can be controlled through sending the RS-232 protocol according to the appendix I section on page 26 to 31.

The RS-232 program can be custom-made to fit for application or it can be used the program provided by Digitalview on request. Please contact your local sales for informations.

MANUAL & REMOTE CONTROL

The following table shows the comparison of functions available from different controls:

Operation	One for All	Sony multi remote	DV switchmount	DV digital VR switchmount	DV remote
Menu	Power	Power	Menu	Menu	OSD Back/Next
-	Mute	Mute	-	-	-
Select +	Ch+	Ch+	Select +	Select +	SEL UP
Select -	Ch-	Ch-	Select -	Select -	SEL DN
Setting +	Vol+	Vol+	Setting +	Setting +	Setting +
Setting -	Vol-	Vol-	Setting -	Setting -	Setting -

Other multi-system IR transmitters will also be suitable if they support common Sony signal timings.

DV remote control unit

BUTTON	FUNCTION
POWER BUTTON	Power ON/OFF button. (Standby mode)
ATTENTION BUTTON	Use combined with digit keys to enable/disable the IR function. DVI-1600 : "Attention" + "1"
MUTE BUTTON	Switch to mute on/off mode.
AV/TV BUTTON	Use to select the input source. (RGB/Composite/S-Video/Component)
ZOOM BUTTON	Use to display the zoom menu. Press the "+" to zoom in the picture and the "-" to zoom out the picture.
SEL UP / SEL DN (BRIGHTNESS) BUTTON	Use this button to direct control the brightness. Press the "SEL UP" button to increase the brightness value and the "SEL DN" button to decrease the brightness value. In OSD menu, pressing this button to select the items.
VOLUME BUTTON	Press the "+" button to increase the volume and the "-" to decrease the volume.
+ / - (CONTRAST) BUTTON	Use this button to direct control the contrast. Press the "+" button to increase the contrast value and the "-" button to decrease the contrast value. In OSD menu, pressing this button to adjust the settings.
PIP BUTTON	Use to display the PIP (picture in picture) window on screen.
OSD BACK BUTTON	Use to display the OSD menu and go to the previous OSD screen.
OSD NEXT BUTTON	Use to display the OSD menu and go to the next OSD screen.
DISPLAY BUTTON	Use to view an on-screen information. When OSD menu displayed, press this button to turn it off.
STOP (RGB) BUTTON	In input source selection mode, pressing this button to select RGB source.
PLAY (YCrCb) BUTTON	In input source selection mode, pressing this button to select Component (YCrCb) source.
TRACK (S-Vid) BUTTON	In input source selection mode, pressing this button to select S-Video source.
TRACK (Comp) BUTTON	In input source selection mode, pressing this button to select Composite source.
FREEZE BUTTON	Use this button to freeze and release the picture on your screen.

Note : For details, please refer to the remote control unit manual.

CONNECTORS, PINOUTS & JUMPERS

The various connectors are:

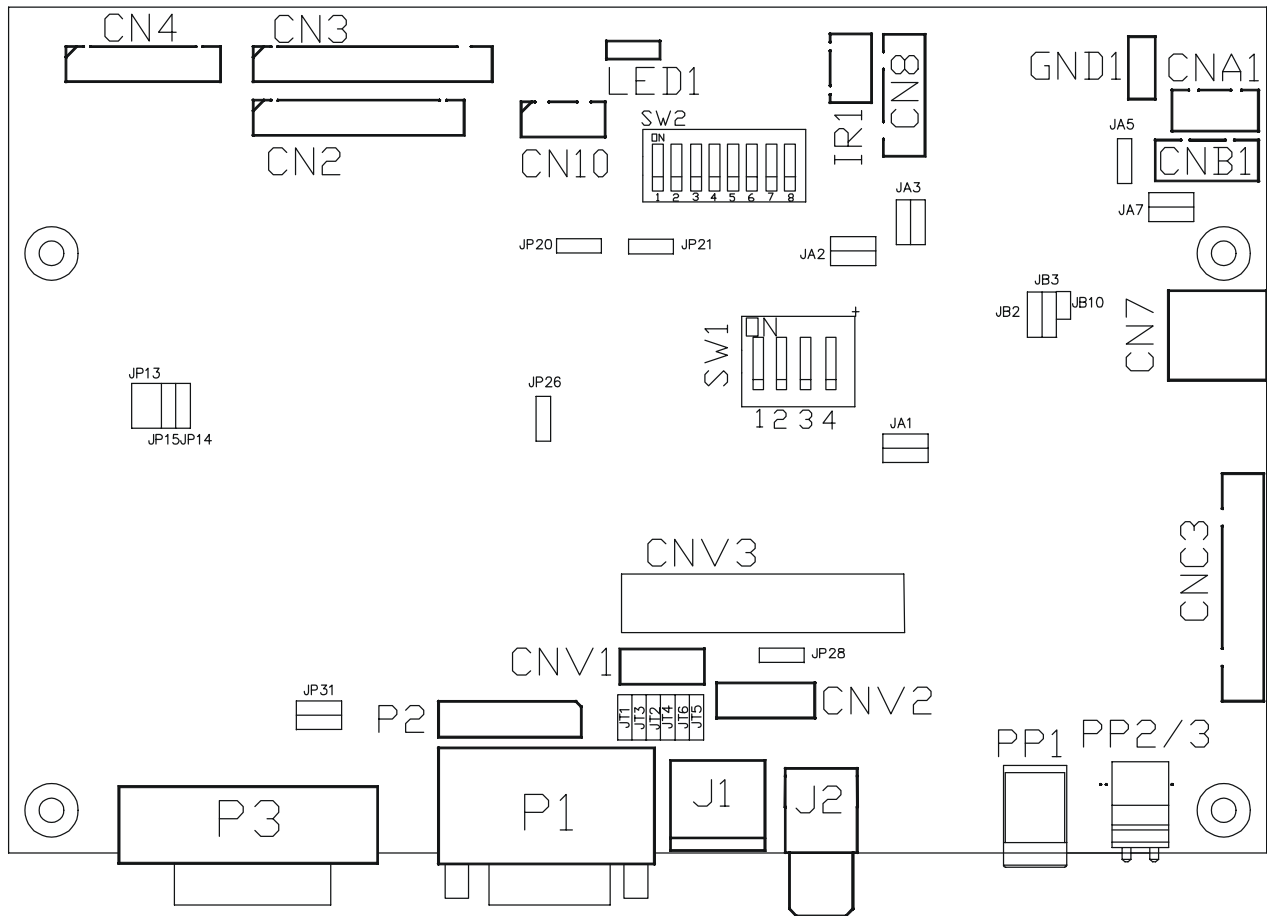

Summary: Connectors

Ref	Purpose	Description
CN2	Panel signal	Hirose 28-pin, DF11-28DP-2DSA (Matching type : DF11-28DS-2C)
CN3	Panel signal	Hirose 32-pin, DF11-32DP-2DSA (Matching type : DF11-32DS-2C)
CN4	Panel signal	Hirose 20-pin, DF11-20DP-2DSA (Matching type : DF11-20DS-2C)
CN7	Audio board connector	DIL socket header 5x2 right angle
CN8	RS-232 serial control	JST 6-way, B6B-XH-A (Matching type : XHP-6)
CN10	Panel signal	Hirose 10-pin, DF11-10DP-2DSA (Matching type : DF11-10DS-2C)
CNA1	Auxiliary power output	JST 4-way, B4B-XH-A (Matching type : XHP-4)
CNB1	Backlight inverter	JST 5-way, B5B-XH-A (Matching type : XHP-5)
CNC3	OSD controls	JST B26B-PHDSS dual row (Matching type : JST PHDR-26VS)
CNV1	Alternate video in	JST 5-way, B5B-PH-K (Matching type : PHR-5)
CNV2	Component video in	JST 6-way, B6B-PH-K (Matching type : PHR-6)
CNV3	Alternate video in	Header pin 13x2
J1	S-video in	Mini din 4-way
J2	Composite video in	RCA jack (yellow)
IR1	Infra-Red sensor connector	JST 3-way, B3B-XH-A (Matching type : XHP-3)
LED1	Dual color LED connector	Header pin 3x1
P1	VGA analog input	DB-15 way high density 3 row
P2	VGA input (alternative)	Pin header, 8 x 2
PP1	Main power input	DC power jack, 2.5mm contact pin diameter
P3	DVI-D input	DVI-D connector
PP2/3	Power input (alternative)	DC power Molex 2 pin 0.156" pitch
SW1	Panel selection	4-way DIP Switch
SW2	Function selection	8-way DIP Switch

Summary: Jumpers setting

Ref	Purpose	Note
JA1	On board +5V logic power enable	1-2 & 3-4 closed, factory set, do not remove
JA2	On board +3.3V logic power enable	1-2 & 3-4 closed, factory set, do not remove
JA3	Panel power voltage select CAUTION: Incorrect setting can damage panel	1-3 & 2-4 = +5V panel voltage (Factory set) 3-5 & 4-6 = +3.3V panel voltage
JA5	+12V panel power	Close = +12V panel power available on CN3 Open = +12V panel power not available on CN3
JA7	+12V power source on connector CNA1	1-3 & 2-4 = DC12V available on pin 1 of CNA1 3-5 & 4-6 = backlight 12V (controlled by JB10) available on pin 1 of CNA1 ** CNA1 provides additional +12V power pin for high current backlight driver board.
JB2	Backlight inverter on/off control – signal level CAUTION: Incorrect setting can damage inverter.	1-2 = On/Off control signal 'High' = +12V 2-3 = On/Off control signal 'High' = +5V Open = On/Off control signal 'High' = Open collector
JB3	Backlight inverter on/off control – polarity	1-2 = control signal 'high' = CCFT ON 2-3 = control signal 'low' = CCFT ON
JB10	Backlight power enable	Open = backlight +12V power supply is always enabled Close = backlight +12V power supply is switched off when backlight is off.
JP13~15	Panel clock select	<i>JP13 JP14 JP15</i> 1-2 1-2 1-2 = 130.0MHz (for UXGA) 1-2 2-3 open = 101.6MHz (for SXGA, SXGA+ ³) 1-2 1-2 2-3 = 81MHz (for WXGA & 1366x768) 1-2 2-3 2-3 = 65MHz (for XGA & 1280x600) 1-2 open open = 32.50MHz (for 852x480) 3-4 1-2 2-3 = 40.6MHz (for SVGA & 852x1024) 3-4 1-2 open = 25.4MHz (for VGA)
JP20	Watchdog timer	1-2 = watchdog timer enabled (Factory set) 2-3 = watchdog timer disabled
JP21	Reserved	Factory set to open
JP26	Reserved	Factory set to open
JP28	Terminator enable for composite video in_3	Close = when composite video in_3 is configured Open = when component video port 2 is set to YCbCr_2 or RGB (SOG) *refer to pin 25 of CNV3
JP30	Reserved	Factory set
JP31	Factory use	Factory set to 1-3, 2-4
JT1	Composite video-in terminator enable	Open = composite video input is not terminated Close = composite video input is terminated with 75Ω
JT2	S-Video luma-in terminator enable	Open = S-video luma input is not terminated Close = S-video luma input is terminated with 75Ω
JT3	S-Video chroma-in terminator enable	Open = S-video chroma input is not terminated Close = S-video chroma input is terminated with 75Ω
JT4	Component luma-in terminator enable	Open = component luma input is not terminated Close = component luma input is terminated with 75Ω
JT5	Component Cr-in terminator enable	Open = component Cr input is not terminated Close = component Cr input is terminated with 75Ω
JT6	Component Cb-in terminator enable	Open = component Cb input is not terminated Close = component Cb input is terminated with 75Ω
SW1	Panel & function selection	See table below
SW2	Function selection	See table below

Panel selection (SW1 + SW2)

SW1-Pos.#1	SW1-Pos.#2	SW1-Pos.#3	SW2-Pos.#1	SW2-Pos.#2	Description
OFF	OFF	ON	OFF	OFF	VGA
ON	OFF	ON	OFF	OFF	SVGA
OFF	ON	ON	OFF	OFF	XGA (single pixel)
OFF	ON	OFF	OFF	OFF	XGA (dual pixel)
ON	ON	ON	OFF	ON	SXGA+ ³ (For IBM ITSX68D/95D)
ON	ON	ON	OFF	OFF	SXGA
ON	OFF	OFF	OFF	OFF	UXGA (For Fujitsu FLC59UXC8V-02) (For IBM ITUX97D)
OFF	OFF	OFF	OFF	OFF	UXGA
ON	OFF	ON	OFF	ON	WSVGA ¹ (For Toshiba LTM10C353S)
OFF	ON	ON	OFF	ON	WXGA ² (single pixel)
OFF	ON	OFF	OFF	ON	WXGA ² (dual pixel)
ON	OFF	OFF	OFF	ON	WXGA ⁴ (1366x768)
OFF	OFF	OFF	ON	OFF	PLASMA (1365 x 768) NEC NP50C1MF01
OFF	OFF	ON	ON	OFF	PLASMA (1024 x 1024) Fujitsu FPF42C128128UA-01
ON	ON	OFF	ON	OFF	PLASMA (852 x 480) NEC NP42B1ME01, NP42B2ME02
ON	ON	ON	ON	OFF	PLASMA (852 x 480) NEC NP4203MF02 Fujitsu FPF42C1066UE-01
ON	OFF	OFF	ON	OFF	PLASMA (852x1024) Fujitsu FPF32C106128UA-01
ON	OFF	ON	ON	OFF	PLASMA (800x600)

Note ¹ : WSVGA - 1280 x 600

Note ² : WXGA - 1280 x 768

Note ³ : SXGA+ - 1400 x 1050

Note ⁴ : WXGA – 1366 x 768 (Apply on P/N 4168800-12 or up / -21 or up version)

Mode selection (SW1)

SW1-Pos. #4 : Clock phase polarity (Use this setting to stabilize the screen display. Please refer to connection diagram for proper setting).

Mode selection (SW2)

SW2-Pos. #3 : Reserved

SW2-Pos. #4 : Reserved

SW2-Pos. #5 : Reserved

SW2-Pos. #6 : Power down mode ON – Enable (Panel interface power remains ON during DPMS down
OFF – Disable (Panel interface power will be turned off during DPMS power Down

SW2-Pos. #7 : YCbCr/RGB-Composite sync ON - RGB-Composite sync
Selection OFF - YCbCr

SW2-Pos. #8 : Video Lock ON - Disable
OFF - Enable

CN2 – Panel connector: HIROSE DF11-28DP-2DSA (Matching type : DF11-28DS-2C)

PIN	SYMBOL	DESCRIPTION
1	GND	Ground
2	GND	Ground
3	ER2	Even data bit R2
4	OR2	Odd data bit R2
5	ER3	Even data bit R3
6	OR3	Odd data bit R3
7	ER4	Even data bit R4
8	OR4	Odd data bit R4
9	ER5	Even data bit R5
10	OR5	Odd data bit R5
11	EG2	Even data bit G2
12	OG2	Odd data bit G2
13	EG3	Even data bit G3
14	OG3	Odd data bit G3
15	EG4	Even data bit G4
16	OG4	Odd data bit G4
17	EG5	Even data bit G5
18	OG5	Odd data bit G5
19	EB2	Even data bit B2
20	OB2	Odd data bit B2
21	EB3	Even data bit B3
22	OB3	Odd data bit B3
23	EB4	Even data bit B4
24	OB4	Odd data bit B4
25	EB5	Even data bit B5
26	OB5	Odd data bit B5
27	GND	Ground
28	GND	Ground

CN3 – Panel connector: HIROSE DF11-32DP-2DSA (Matching type : DF11-32DS-2C)

PIN	SYMBOL	DESCRIPTION
1	+12v	DC +12v, reserved & not normally used
2	+12v	DC +12v, reserved & not normally used
3	VLCD12	Optional +12V panel supply (selected by JA5)
4	NC	No connection
5	GND	Ground
6	GND	Ground
7	ER6	Even data bit R6
8	OR6	Odd data bit R6
9	ER7	Even data bit R7 (MSB of lower colour bit panels)
10	OR7	Odd data bit R7 (MSB of lower colour bit panels)
11	EG6	Even data bit G6
12	OG6	Odd data bit G6
13	EG7	Even data bit G7 (MSB of lower colour bit panels)
14	OG7	Odd data bit G7 (MSB of lower colour bit panels)
15	EB6	Even data bit B6
16	OB6	Odd data bit B6
17	EB7	Even data bit B7 (MSB of lower colour bit panels)
18	OB7	Odd data bit B7 (MSB of lower colour bit panels)
19	GND	Ground
20	GND	Ground
21	Vcc	DC +5v, reserved & not used normally
22	Vcc	DC +5v, reserved & not used normally
23	VS	Vertical sync
24	PWRDN	Power down control signal (5v TTL)
25	HS	Horizontal sync
26	DE	Display enable
27	VLCD	Panel power supply (3.3V/5V configurable)
28	VLCD	Panel power supply (3.3V/5V configurable)
29	CKE	Even dot clock
30	CKO	Odd dot clock
31	GND	Ground
32	GND	Ground

CN4 – Panel connector: HIROSE DF11-20DF-2DSA (Matching type : DF11-20DS-2C)

PIN	SYMBOL	DESCRIPTION
1	GND	Ground
2	GND	Ground
3	NC	No connection
4	NC	No connection
5	ER0	Even data bit R0 (LSB)
6	OR0	Odd data bit R0 (LSB)
7	ER1	Even data bit R1
8	OR1	Odd data bit R1
9	EG0	Even data bit G0 (LSB)
10	OG0	Odd data bit G0 (LSB)
11	EG1	Even data bit G1
12	OG1	Odd data bit G1
13	EB0	Even data bit B0 (LSB)
14	OB0	Odd data bit B0 (LSB)
15	EB1	Even data bit B1
16	OB1	Odd data bit B1
17	NC	No connection
18	ODD_FIELD	Odd field (when connected to an interlace panel)
19	GND	Ground
20	GND	Ground

CN7 - Audio connector: DIL socket header 5x2 right angle

PIN	SYMBOL	DESCRIPTION
1	VCC	Audio board logic power supply, +5V
2	VOLSEL0	Volume control select signal
3	VOLSEL1	Volume control select signal
4	DATA/DN	Data for audio volume control
5	CLK	Clock for audio volume control
6	GND	Ground
7	+12V	Audio board power supply, +12V
8	LIN	Audio left channel L (re-route RCA connector to audio board)
9	RIN	Audio right channel R (re-route RCA connector to audio board)
10	AUDIO_GND	Ground for audio analog

CN8 – RS-232 serial control: JST B6B-XH-A (Matching type : XHP-6)

PIN	SYMBOL	DESCRIPTION
1	SDATA	Reserved
2	SCLK	Reserved
3	VCC	+5V
4	TXD	RS-232 Tx data
5	GND	Ground
6	RXD	RS-232 Rx data

CN10 – Panel signal : Hirose 10-pin, DF11-10DP-2DSA (Matching type : DF11-10DS-2C)

PIN	SYMBOL	DESCRIPTION
1	PORT 0	Panel configuration port 0
2	PORT 1	Panel configuration port 1
3	PORT 2	Panel configuration port 2
4	BLON	Hpower-ENA(High voltage power enable for panel/address drivers)
5	PORT 3	Panel configuration port 3
6	PORT 4	Panel configuration port 4
7	PORT 5	Panel configuration port 5
8	NC	No connection
9	GND	Ground
10	PORT 6	Panel configuration port 6

CNA1 - Auxiliary power output: JST B4B-XH-A (Matching type : XHP-4)

PIN	SYMBOL	DESCRIPTION
1	AUX 12V	+12V DC, 500mA max
2	GND	Ground
3	GND	Ground
4	AUX 5V	+5V DC, 500mA max

CNB1 – Backlight inverter connector: JST B5B-XH-A (Matching type : XHP-5)

PIN	SYMBOL	DESCRIPTION
1	GND	Ground
2	VBKL	+12VDC, backlight power supply
3	BLCTRL	On/Off control (enable) – see JB2 & JB3
4	NC	No connection
5	NC	No connection

CNC3 – Function controls connector: JST B26B-PHDSS dual row (Matching type : JST PHDR-26VS)

PIN	SYMBOL	DESCRIPTION
1	+12VDC	+12VDC in
2	+12VDC	+12VDC in
3	+12VDC	+12VDC in
4	GND	Ground
5	GND	Ground
6	GND	Ground
7	PSWIN	Power switch A
8	SW_ON	Power switch B
9	GND	Ground
10	MENU	OSD menu button
11	-/LEFT	OSD -/Left button
12	+ /RIGHT	OSD +/Right button
13	SEL_DN	OSD select down button
14	SEL_UP	OSD select up button
15	NC	No connection
16	Green	Green LED pin (anode)
17	Common	LED pin common (cathode)
18	Red	Red LED pin (anode)
19	Vcc	+5V
20	TXD	RS-232 Tx data
21	GND	Ground
22	RXD	RS-232 Rx data
23	GND	Ground
24	STDBY_Vcc	Standby voltage
25	IR Data	IR data
26	BLCTRL	Backlight on/off control

CNV1 – Alternate Video in input, JST B5B-PH-K (Matching type : PHR-5)

PIN	DESCRIPTION
1	S-Video : Chroma in
2	S-Video : Luma in
3	Ground
4	Ground
5	Composite video in

CNV2 – Component Video in input, JST B6B-PH-K (Matching type : PHR-6)

PIN	DESCRIPTION
1	Luma in /Green in
2	Ground
3	Cb in / Blue in
4	Ground
5	Cr in / Red in
6	Ground

CNV3 – Auxiliary Video input connector, DIL socket header 13x2

PIN	DESCRIPTION
1	S-Video : Chroma in
2	Ground
3	S-Video : Luma in
4	Ground
5	Composite video in
6	Ground
7	Luma in / Green in
8	Ground
9	Cb in / Blue in
10	Ground
11	Cr in / Red in
12	Ground
13	S-Video_2 : Chroma in
14	Ground
15	S-Video_2 : Luma in
16	Ground
17	Composite video in_2
18	Ground
19	Cr in_2 / Red in_2
20	Ground
21	Luma in_2/Green in_2
22	Ground
23	Cb in_2 / Blue_2
24	Ground
25	Composite sync in / Composite video in_3
26	Ground

IR1 – Infra-Red sensor connector: JST B3B-XH-A (Matching type : XHP-3)

PIN	SYMBOL	DESCRIPTION
1	GND	Ground
2	STDBY_Vcc	Stand by voltage
3	IR Data	IR data

LED1 – Status LED connector: 3-pin header

PIN	DESCRIPTION
1	Green LED pin (anode)
2	LED pin common (cathode)
3	Red LED pin (anode)

P1 - Analog VGA in - 15 way connector

PIN	SYMBOL	DESCRIPTION
1	PCR	Red, analog
2	PCG	Green, analog
3	PCB	Blue analog
4	ID2	Reserved for monitor ID bit 2 (grounded)
5	DGND	Digital ground
6	AGND	Analog ground red
7	AGND	Analog ground green
8	AGND	Analog ground blue
9	DDC_5V	+5V power supply for DDC (optional)
10	DGND	Digital ground
11	ID0	Reserved for monitor ID bit 0 (grounded)
12	DDC_SDA	DDC serial data
13	HS_IN	Horizontal sync or composite sync, input
14	VS_IN	Vertical sync, input
15	DDC_SCL	DDC serial clock

P2 - Alternate VGA in – DIL socket header 8x2

PIN	SYMBOL	DESCRIPTION
1	PCR	Red, analog
2	PCG	Green, analog
3	PCB	Blue analog
4	ID2	Reserved for monitor ID bit 2 (grounded)
5	DGND	Digital ground
6	AGND	Analog ground red
7	AGND	Analog ground green
8	AGND	Analog ground blue
9	DDC_5V	+5V power supply for DDC (optional)
10	DGND	Digital ground
11	ID0	Reserved for monitor ID bit 0 (grounded)
12	DDC_SDA	DDC serial data
13	HS_IN	Horizontal sync or composite sync, input
14	VS_IN	Vertical sync, input
15	DDC_SCL	DDC serial clock
16	NC	No connection

P3 – DVI-D input

PIN	SYMBOL	DESCRIPTION
1	/RX2	TMDS Data 2-
2	RX2	TMDS Data 2+
3	GND	Digital Ground
4	NC	No connection
5	NC	No connection
6	DVI_DDC_CLK	DDC Clock
7	DVI_DDC_DAT	DDC Data
8	DVI_VS_IN	Analog vertical Sync
9	/RX1	TMDS Data 1-
10	RX1	TMDS Data 1+
11	GND	Digital Ground
12	NC	No connection
13	NC	No connection
14	DVI_DDC_5V	+5V power supply for DDC (optional)
15	GND	Ground (+5, Analog H/V Sync)
16	NC	No connection
17	/RX0	TMDS Data 0-
18	RX0	TMDS Data 0+
19	GND	Digital Ground
20	NC	No connection
21	NC	No connection
22	GND	Digital Ground
23	RXC	TMDS Clock+
24	/RXC	TMDS Clock-
25	NC	No connection
26	NC	No connection

PP1 - 12VDC power supply

PIN	DESCRIPTION
1	+12VDC in middle pin
2	Ground

PP2/PP3 – Alternate 12VDC power supply

PIN	DESCRIPTION
1	+12VDC in
2	Ground

CONTROLLER DIMENSIONS

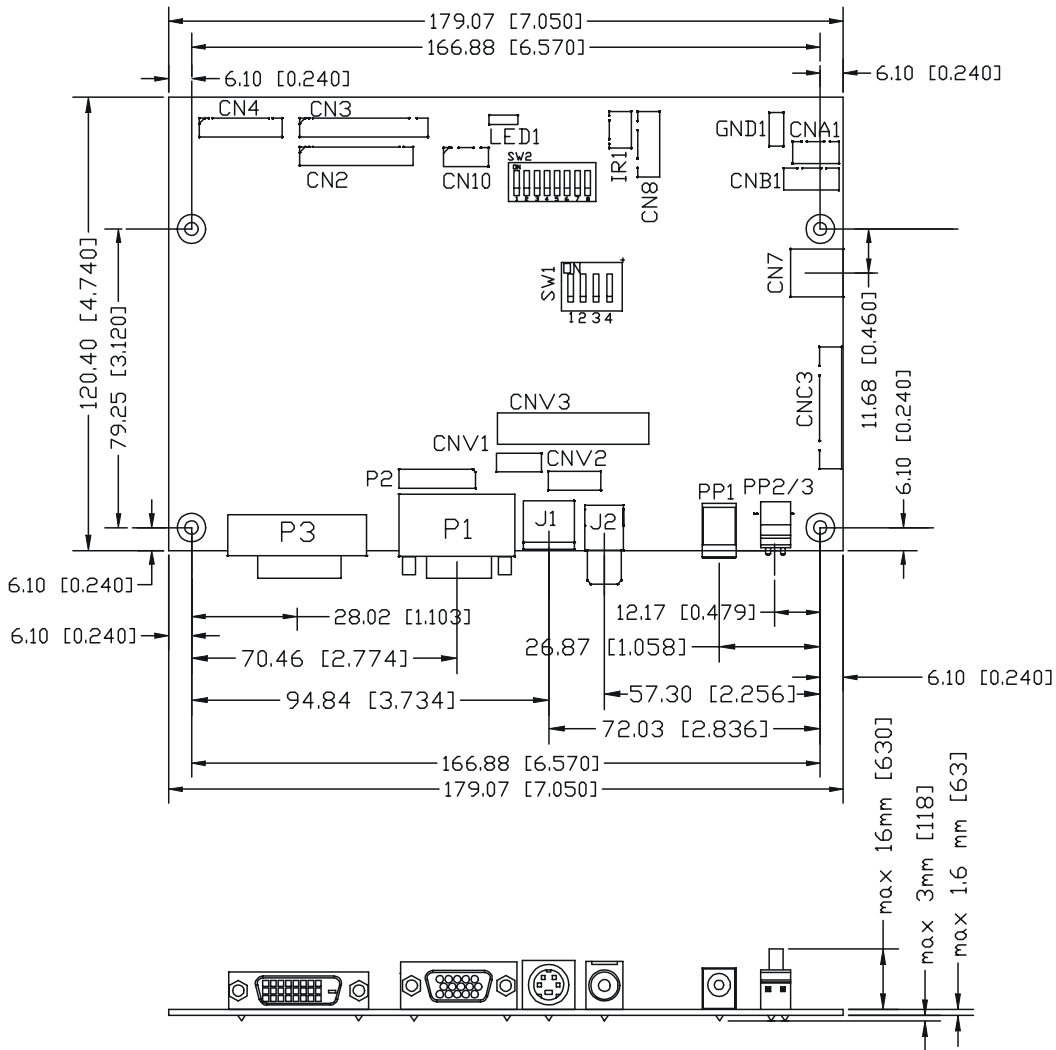

The maximum thickness of the controller is 20.6mm with or without video add-on board (measured from bottom of PCB to top of components, including any underside components & leads). We recommend clearances of:

- 5mm from bottom of PCB - if mounting on a metal plate we also recommend a layer of suitable insulation material is added to the mounting plate surface.
- 10mm above the components
- 3~5mm around the edges

Any of the holes shown above can be used for mounting the PCB, they are 3.2mm in diameter.

CAUTION: Ensure adequate insulation is provided for all areas of the PCB with special attention to high voltage parts such as the inverter.

APPLICATION NOTES

USING THE CONTROLLER WITHOUT BUTTONS ATTACHED

This is very straightforward by following the steps below :

- Firstly setup the controller/display system with the buttons. With controls attached and display system active make any settings for colour, tint and image position as required then switch everything off.
- Remove the control switches, the switch mount (CNC3) cable.
- Use a jumper or similar to connect pins 7 & 8 on CNC3, this will fix the board On.
- Refer to inverter specifications for details as to fixing brightness to a desired level, this may require a resistor, an open circuit or closed circuit depending on inverter.

INVERTER CONNECTION

There are potentially 3 issues to consider with inverter connection:

- Power
- Enable
- Brightness

Please read the following sections for a guide to these issues.

Inverter Power: As per the table for CNB1 pin 1 is ground and pin 2 provides 12V DC. This should be matched with the inverter specification: see table.

CNB1

PIN	DESCRIPTION
1	Ground
2	+12VDC

Remark: For higher power inverter, more current (for 12V) can be taken from CNA1 pin 1.

Enable: This is a pin provided on some inverters for On/Off function and is used by this panel controller for VESA DPMS compliance. If the inverter does not have an enable pin or the enable pin is not used then DPMS will not be operational. Pin 3 should be matched to the inverters specification for the 'enable' or 'disable' pin.

CNB1

PIN	DESCRIPTION
3	Enable

Further, jumpers JB2 & JB3 should be set to match the inverters specification for the enable pin power and High or Low setting: see table.

Ref	Purpose	Note
JB2	Inverter enable voltage	1-2 H = 12V, 2-3 H = 5V (Vcc), OPEN H = open collector
JB3	Inverter control	1-2 H = On, 2-3 L = On

Brightness: There are various methods for brightness control and it is important to consider the specifications for the inverter to be used. Generally the situation is:

- Brightness can controlled by using a resistor or VR (Variable Resistor).
- Brightness controlled by adding a circuit such as PWM (Pulse Width Modulation).
- No adjustment of brightness is possible.

CNB1 pins 4 & 5 are available for connecting to an inverter or circuit where VR control is supported.

CNB1

PIN	DESCRIPTION
4	VR WIP
5	VR A

This can then be matched with function controls (OSD switch mount) pins 3 & 4: see cable design below .

CASE 1 : The inverter cable connector (HS3 & HS4) connects directly to the controller board connector CNA1 & CNB1 :

Solder the red loose wire come from OSD cable P/N 4261209-00 to HS3 pin 4
Solder the black loose wire come from OSD cable P/N 4261209-00 to HS3 pin 5

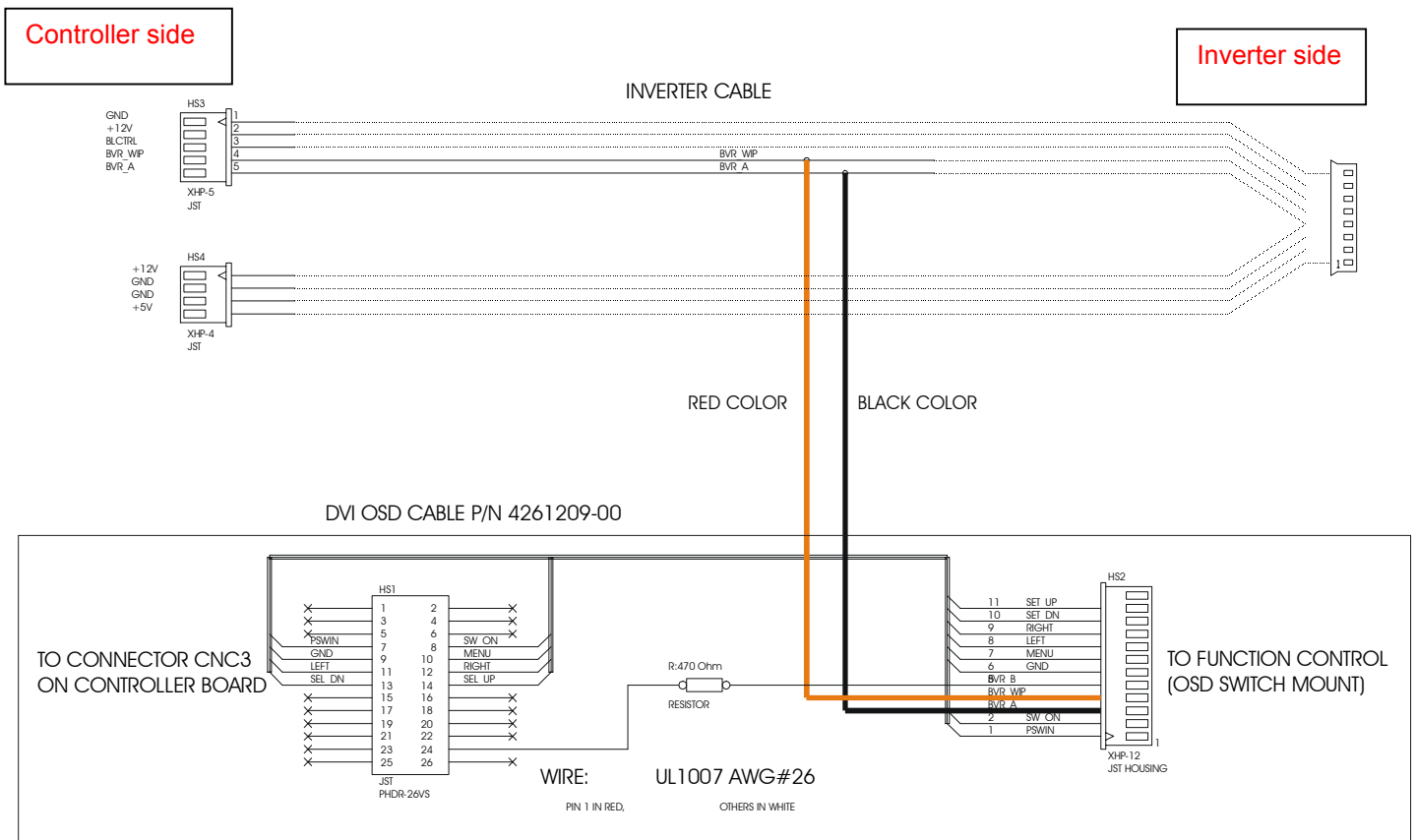

CASE 2 : Inverter cable connector (HS3 & HS4) connect to the inverter interface board P/N 4160400-10 connector (CNB2 & CNB3)

Solder the red loose wire come from OSD cable P/N 4261209-00 to HS3 pin 7
 Solder the black loose wire come from OSD cable P/N 4261209-00 to HS3 pin 8

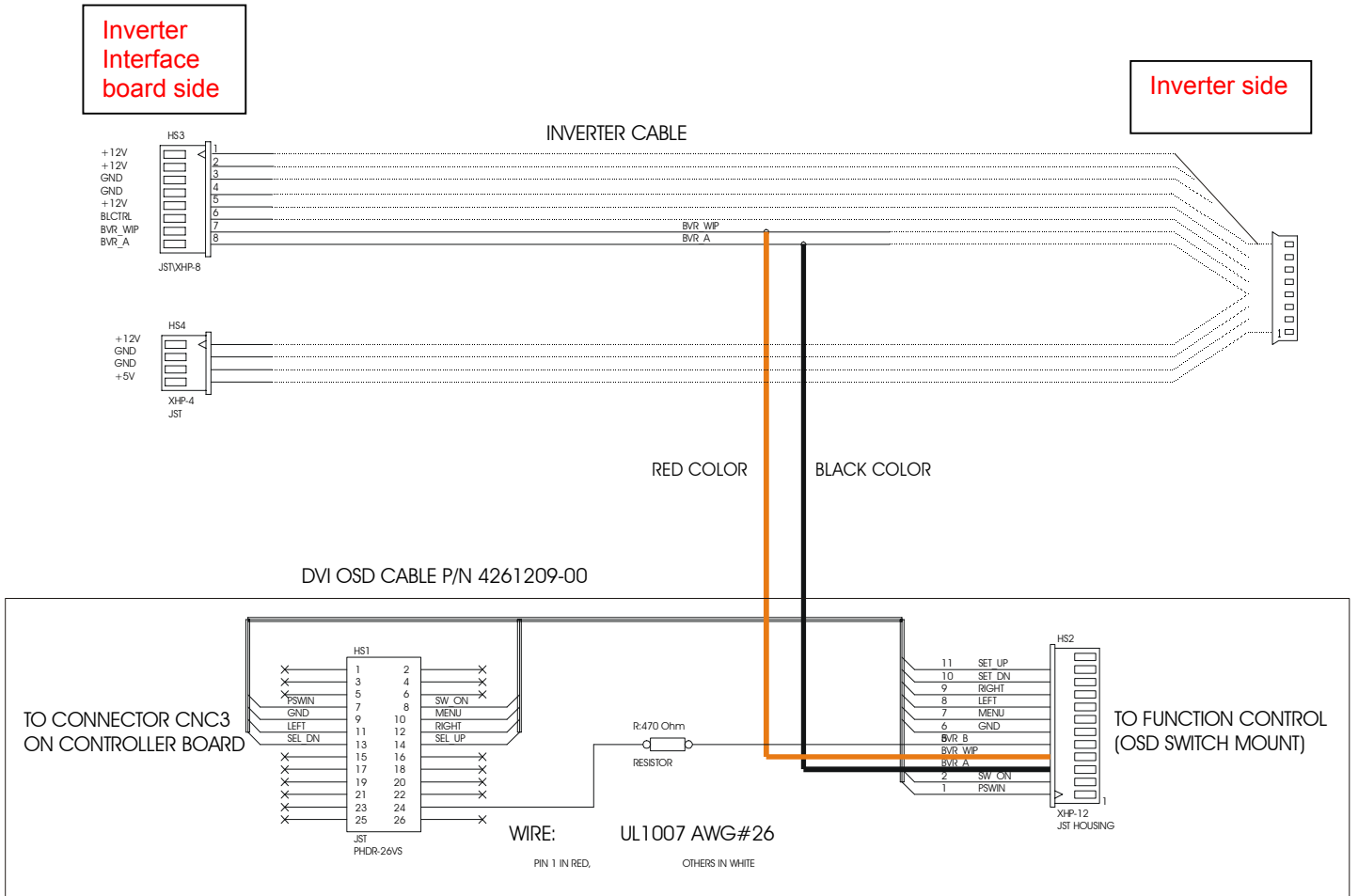

CNV3 – AUXILIARY VIDEO INPUT CONNECTION

The DVI-1600 features 2 sets of video inputs (Primary/Secondary) for various video signals. It accepts the input signal of Composite, S-Video, Component (YCbCr), RGB-Video (RGB-SOG / RGB Composite sync).

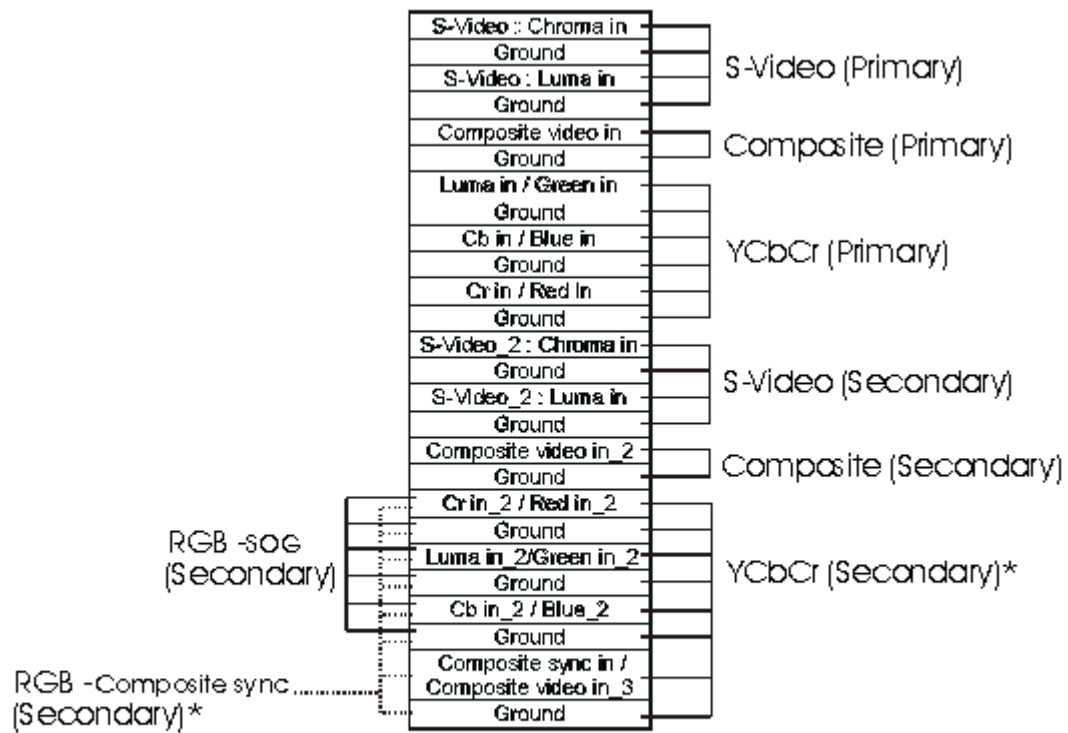

* YCbCr/RGB-Composite sync can be selected by dip switch SW2 position 7, see as page 14.

TROUBLESHOOTING

General

A general guide to troubleshooting a flat panel display system it is worth considering the system as separate elements, such as:

- Controller (jumpers, PC settings)
- Panel (controller, cabling, connection, panel, PC settings)
- Backlight (inverter, cabling, backlight tubes)
- Cabling
- Computer system (display settings, operating system)

Through step by step cross checking with instruction manuals and a process of elimination to isolate the problem it is usually possible to clearly identify the problem area.

No image:

- If the panel backlight is not working it may still be possible to just see some image on the display.
- A lack of image is most likely to be caused by incorrect connection, lack of power, failure to provide a signal or incorrect graphic card settings.

Image position:

If it is impossible to position the image correctly, ie the image adjustment controls will not move the image far enough, then test using another graphics card. This situation can occur with a custom graphics card that is not close to standard timings or if something is in the graphics line that may be affecting the signal such as a signal splitter (please note that normally a signal splitter will not have any adverse effect).

Image appearance:

- A faulty panel can have blank lines, failed sections, flickering or flashing display
- Incorrect graphics card refresh rate, resolution or interlaced mode will probably cause the image to be the wrong size, to scroll, flicker badly or possibly even no image.
- Incorrect jumper settings on the controller may cause everything from total failure to incorrect image. CAUTION: Do not set the panel power input incorrectly.
- Sparkling on the display: faulty panel signal cable.

Backlight:

Items to check include: Power input, Controls, Inverter and Tubes generally in this order.

If half the screen is dimmer than the other half:

- Check cabling for the inverter.
- For a specific backlight tube check the AC pins orientation (CAUTION: Never reverse any DC power pins).

Also:

- If adjusting brightness control has no effect the chances are that the VR rating or method of adjusting brightness is not compatible or correctly connected to the inverter.
- If system does not power down when there is a loss of signal

Continued failure:

If unit after unit keeps failing consider and investigate whether you are short circuiting the equipment or doing something else seriously wrong.

Generally after common sense issues have been resolved we recommend step by step substitution of known working parts to isolate the problem.

SPECIFICATIONS

Panel compatibility	Compatible with 1600x1200, 1366x768, 1280x1024, 1280x768, 1280x600, 1024 x 768, 800x600 & 640x480 resolutions of TFT LCD panels from manufacturers such as: Toshiba, Sharp, Samsung, Philips/Hosiden, NEC, Mitsubishi/ADI, LG, IBM, Hitachi, Fujitsu, etc Supported with 852x480 resolutions of Plasma panels - Fujitsu 42" Plasma (FPF42C1066UE-01 and FPF42C128128UA-01), NEC 42" Plasma (NP4203MF02 and NP42B1ME01), NEC 50" Plasma (NP50C1MF01), 1024x1024, 1280x768, 1365x768 resolutions to be supported. A specified BIOS and some factory adjustment may be required for individual panel timings.
No. of colours	Up to 3 x 8 bit providing 16.7 million colours.
Panel power	DC 3.3V, 5V, 12V
Panel signal	TTL with LVDS & TMDS options (through add-on board)
Vertical refresh rate	60Hz at UXGA and up to 85Hz other lower resolution
Dot clock (pixel clock) maximum	280MHz
Graphics formats	Standard VESA VGA, SVGA, XGA, SXGA & UXGA; Other special formats through specified BIOS and factory adjustment.
Graphics auto mode detect	VGA, SVGA, XGA, SXGA & UXGA interlaced and non-interlaced
Standard input at source (analog RGB)	VGA analog (15 pin) standard with automatic detection of: DVI-D Digital Separate Sync; Composite Sync Sync On Green.
Video formats	PAL, NTSC & SECAM
Video inputs	Composite video S-Video Component video (YCbCr) RGB Video (SOG / Composite Sync)
Functions display	On screen display (OSD) of functions
OSD menu functions	Image controls: Panel brightness/contrast, Color Temperature, Video Adjustment, Video System, Position, PIP, Rotation, Gamma, Video Scaling, Language, Video source, Utilities, Volume
OSD menu controls available	Power On/Off Backlight brightness OSD Menu OSD Select up OSD Select down Setting + Setting -
Control interface	Buttons Infra red RS-232 serial control
Settings memory	Settings are stored in non volatile memory
PC Connectivity	VGA / SVGA / XGA / SXGA / UXGA analog
Controller dimensions	179mm x 120.4mm (7." x 4.74")
Power consumption	10w approx. (not including panel power consumption)
Power load maximum	The controller has an overall 3Amp current limit.
Input voltage	12VDC
Power protection	Fuse fitted
DC Power handling	An on board relay handles the power load for On/Off and power protection to the LCD.
Storage temperature limits	-40°C to +70°C
Operating temperature limits	0°C to +60°C

NOTES

Please note the following:

- For specific panel setup a sample of an LCD may be required (this will be returned) and a copy of the full technical specifications for the panel from the manufacturer.
- Re-layout and custom development services are available.

APPENDIX I – RS-232 COMMAND PROTOCOL

1. Commands to implement switch mount control buttons

Function	Command	Description	Remark
Menu button	0xf7	Menu button pressed	Button equivalent
Select-down button	0xfa	Select-down button pressed	Button equivalent
Select-up button	0xfb	Select-up button pressed	Button equivalent
Right/+ button	0xfc	Right/+ button pressed	Button equivalent
Left/- button	0xfd	Left/- button pressed	Button equivalent

2. Parameter setting - immediate, relative, reset and query

Function	Command	Description	Acknowledge (if enabled)
Volume control - left+right channel	0x80, "a" "A", nn "+" "-" "r" "R" "?"	Set audio (L+R) volume = value/increment/decrement Reset Query	volume left.
Volume control - on/off (mute)	0x80, "m" "M", "0" "1" "r" "R" "?"	Disable audio output. Enable audio output. Reset Query	"0" - audio off (muted). "1" - audio on.
Brightness control	0x81, nn "+" "-" "r" "R" "?"	Set brightness = value/increment/decrement Reset Query	Brightness.
Contrast control - all channels	0x82, "a" "A", nn "+" "-" "r" "R" "?"	Set all contrast = value/increment/decrement Reset Query	Contrast red.
Color control	0x83, nn "+" "-" "r" "R" "?"	Set color = value/increment/decrement Reset Query	PAL/NTSC color (In video mode only)
Tint control	0x84, nn "+" "-" "r" "R" "?"	Set tint = value/increment/decrement Reset Query	NTSC tint (In NTSC mode only)
Phase (tuning) control	0x85, nn "+" "-" "r" "R" "?"	Set dot clock phase = value/increment/decrement Reset Query	Dot clock phase. (In PC mode only)
Image H position	0x86, nnnn "+" "-" "r" "R" "?"	Set img_hpos = value/increment/decrement Reset Query	Image horizontal position.
Image V position	0x87, nnnn "+" "-" "r" "R" "?"	Set img_vpos = value/increment/decrement Reset Query	Image vertical position.

Sharpness	0x8a, n "+" "-" "r" "R" "?"	Set sharpness = value/increment/decrement Reset Query	Sharpness.
Graphic mode H active size	0x8b, nnnn "+" "-" "?"	Set H active size = Value/increment/decrement Query	Graphic mode H active size (in pixels)
Scaling Mode	0x8c, "0" "1" "2" "3" "r" "R" "?"	Set graphic image scaling mode = value Reset Query	Image expansion on/off. "0" – 1:1. "1" – fill screen. "2" – fill to aspect ratio "3" – non-linear scaling "4" – expand letterbox video to fill screen "5" – expand letterbox video (with subtitles) to fill screen "6" – keep aspect ratio of 4:3 video on 16:9 screen "7" – expand 4:3 letterbox video to aspect ratio (on 16:9 screen) "8" – expand 4:3 letterbox video (with subtitles) to aspect ratio (on 16:9 screen)
Set display orientation	0x8e, n "r" "R" "?"	Set display orientation = value/increment/decrement Reset Query	"0" – normal. "1" – vertical inverse. "2" – horizontal inverse. "3" – inverted.
Rotate OSD	0x8f, "0" "1" "?"	Disable/enable OSD rotate Query	"0" – normal OSD. "1" – rotated OSD.
OSD H position	0x90, nnn "+" "-" "r" "R" "?"	Set osd_hpos = value/increment/decrement Reset Query	OSD horizontal position.
OSD V position	0x91, nnn "+" "-" "r" "R" "?"	Set osd_vpos = value/increment/decrement Reset Query	OSD vertical position.
OSD Transparency	0x92, n "+" "-" "r" "R" "?"	Set OSD transparency = value/increment/decrement Reset Query	OSD transparency.
Select menu timeout	0x93, nn "+" "-" "r" "R" "?"	Select menu timeout = value/increment/decrement Reset Query	OSD menu timeout value. "00" – Continuous. value – Round up to nearest available step. if value > max available step, set it to the max available step.
Select autosave mode	0x94, "0" "1" "r" "R" "?"	Select autosave = On/Off Reset Query	"0" - autosave off. "1" - autosave on.
Select OSD language	0x95, n "r" "R" "?"	Select language = English, Italian,... Reset Query	"0" – English. "7" – Danish "8" – Chinese
Input main select	0x98, n "+" "-" "r" "R" "?"	Select input main = PC or VIDEO or next available Reset Query	Main selected. "0" – PC. "1" – Composite video. "2" – S-video. "3" – Component video. "4" – DVI.
Source Priority	0x99, "0" "1" "r" "R" "?"	Set exclusive or priority = Exclusive/Priority Reset Query	"0" – Exclusive. "1" – Priority. "2" – Priority during power up.
Video System	0x9b, "0" "1" "2" "3" "r" "R" "?"	Set video system = Auto/NTSC/PAL/SECAM Reset Query	"0" – Auto. "1" – NTSC_M_358 "2" – PAL_N_443 "3" – SECAM "4" – NTSC_M_443 "5" – PAL_M_358 "6" – NTSC_N_358 "7" – PAL_M_443 "8" – NTSC_N_443 "9" – PAL_N_358 (In video mode only)

Video source type select	0x9c, n "r" "R" "?"	Select video source type = Value Reset Query	Video source type: "0" – DVD "1" – VCR
GAMMA value select	0x9d, n "r" "R" "?"	Select GAMMA value = Value Reset Query	GAMMA value: "0" – 1.0, "1" – 1.6 "2" – 2.2, "3" – User Defined
Power Down / DPMS Option	0x9f, "0" "1" "r" "R" "?"	Set power down option = On/Off Reset Query	"0" – Off. "1" – On.
Direct Access (Hotkeys)	0xa0, "1", n "r" "R" "?"	Set Hotkey 1 = value Reset Query	"0" – audio mute. "1" – volume. "2" – brightness. "3" – contrast. "4" – color. "5" – input source. "6" – video input. "7" – zoom "8" – freeze "9" – PIP
Direct Access (Hotkeys)	0xa0, "2", n "r" "R" "?"	Set Hotkey 2 = value Reset Query	"0" – audio mute. "1" – volume. "2" – brightness. "3" – contrast. "4" – color. "5" – input source. "6" – video input. "7" – zoom "8" – freeze "9" – PIP
Set runtime counter	0xa1, nnnnn "r" "R" "?"	Set runtime counter value = nnnnn (* 0.5 hour) Reset Query	Runtime = nnnnn.
PIP brightness control	0xa2, nn "+" "-" "r" "R" "?"	Set PIP window brightness = value/increment/decrement Reset Query	PIP window brightness.
PIP contrast control	0xa3, nn "+" "-" "r" "R" "?"	Set PIP window contrast = value/increment/decrement Reset Query	PIP window contrast.
PIP H position	0xa4, nnn "+" "-" "r" "R" "?"	Set PIP_hpos = value/increment/decrement Reset Query	PIP window horizontal position.
PIP V position	0xa5, nnn "+" "-" "r" "R" "?"	Set PIP_vpos = value/increment/decrement Reset Query	PIP window vertical position.

PIP window size select	0xa6, nn "+" "-" "r" "R" "?"	Select PIP window size = PIP window size value Reset Query	Main selected. PIP off if "nn" = "00".
PIP source select	0xa7, n "+" "-" "r" "R" "?"	Select input main = Video source value Reset Query	Main selected. "0" – auto. "1" – Composite video. "2" – S-video. "3" – Component video.
Zoom level	0xa8, nn "+" "-" "r" "R" "?"	Set Zoom level = value/increment/decrement Reset Query	Zoom level.
Zoom H position	0xa9, nnn "+" "-" "r" "R" "?"	Set Zoom_hpos = value/increment/decrement Reset Query	Zoom window horizontal position.
Zoom V position	0xaa, nnn "+" "-" "r" "R" "?"	Set Zoom_vpos = value/increment/decrement Reset Query	Zoom window vertical position.
Scalar H Clipping	0xab, nnn "+" "-" "r" "R" "?"	Set the horizontal clipping size for non-linear scale mode = value/increment/decrement Reset Query	Scalar horizontal clipping
Scalar H Offset	0xac, nnn "+" "-" "r" "R" "?"	Set the horizontal offset of the display window for non-linear scale mode = value/increment/decrement Reset Query	Scalar horizontal offset.
Scalar H stretch	0xad, nnn "+" "-" "r" "R" "?"	Set horizontal stretch factor for non-linear scale mode = value/increment/decrement Reset Query	Scalar horizontal stretch.
Scalar V Clipping	0xae, nnn "+" "-" "r" "R" "?"	Set the vertical clipping size for non-linear scale mode = value/increment/decrement Reset Query	Scalar vertical clipping
Scalar V Offset	0xaf, nnn "+" "-" "r" "R" "?"	Set the vertical offset of the display window for non-linear scale mode = value/increment/decrement Reset Query	Scalar vertical offset.
Scalar V stretch	0xb0, nnn "+" "-" "r" "R" "?"	Set vertical stretch factor for non-linear scale mode = value/increment/decrement Reset Query	Scalar vertical stretch.
Scalar H pan position	0xb1, nnn "+" "-" "r" "R" "?"	Set horizontal pan position for 1:1 scale mode = value/increment/decrement Reset Query	Scalar horizontal pan position.
Scalar V pan position	0xb2, nnn "+" "-" "r" "R" "?"	Set vertical pan position for 1:1 scale mode = value/increment/decrement Reset Query	Scalar vertical pan position.
Colour temperature select	0xb3, n "+" "-" "r" "R" "?"	Select colour temperature = value Reset Query	Main selected. "0" – 9500K. "1" – 8000K. "2" – 6500K. "3" – 5000K.
Red level for selected colour temperature	0xb4, nn "+" "-" "r" "R" "?"	Set the level of the red channel for the selected colour temp. = value/increment/decrement Reset Query	Red level for selected colour temperature.

Green level for selected colour temperature	0xb5, nn "+" "-" "r" "R" "?"	Set the level of the green channel for the selected colour temp. = value/increment/decrement Reset Query	Green level for selected colour temperature.
Blue level for selected colour temperature	0xb6, nn "+" "-" "r" "R" "?"	Set the level of the blue channel for the selected colour temp. = value/increment/decrement Reset Query	Blue level for selected colour temperature.
Graphic horizontal resolution enquiry	0xb7	Horizontal resolution (in pixels) in 3 digit hex number	"nnn" = horizontal resolution
Graphic vertical resolution enquiry	0xb8	Vertical resolution (in lines) in 3 digit hex number	"nnn" = vertical resolution
Graphic horizontal sync frequency	0xb9	Horizontal sync frequency (in units of 100Hz) in 3 digit hex number	"nnn" = horizontal frequency
Graphic vertical sync frequency	0xba	Vertical sync frequency (in units of Hz) in 3 digit hex number	"nnn" = vertical frequency
OSD status enquiry	0xbb	Status of OSD	"0" – OSD turned off "1" – OSD turned on
Display Video Source Select	0xbc, "?" "0" "1"	Query Name of video source not displayed. After switching to a new video source, the name of the video source is displayed for 5 seconds.	"0" – disabled. "1" – enabled.
OSD turn off	0xbd	Turn off the OSD.	"0" – fail. "1" – successful.
Select Video Port	0xbe, "0", "?" 0xbe "0", "R" "r" 0xbe, "0", n 0xbe, "1", "?" 0xbe, "1", "R" "r" 0xbe, "1", n 0xbe, "2", "?" 0xbe, "2", "R" "r" 0xbe, "2", n	Query Composite Video Port No. Set Composite Video Port No. = "0" Set Composite Video Port Number Query Svideo Port Number Set Svideo Port Number = "0" Set Svideo Port Number Query Component Video Port No. Set Component Vid. Port No. = "0" Set Component Video Port Number	"0n" – Port number
Set gamma data for user defined gamma curve	0xbf, mm, c, "?" 0xbf, "R" "r" 0xbf, mm, c, nn	Query gamma data for color c index mm (c = 0 for color Red, c=1 for color Green, c=2 for color Blue) Set user gamma curve to linear Set gamma data for color c index mm. (If c= 3, then gamma data for red, green & blue will be set at the same time.)	"nn" = gamma data "1" "nn" = gamma data

3. Other control

Function	Command	Description	Acknowledge (if enabled)
Select RS-232 acknowledge	0xc1, "0" "1"	Disable/enable command acknowledge.	"0" – acknowledge disabled. "1" – acknowledge enabled.
Select video mode	0xc2, nn	Current vmode = nn.	Current video mode selected.
Auto-setup	0xc3	Start auto-setup of current vmode.	"0" – fail. "1" – successful.
Command availability	0xc4, nn	Check whether a command is available.	"0" – not available. "1" – available.
Auto-calibration	0xc5	Start auto-calibration of gain of the RGB amplifier.	"0" – fail. "1" – successful.
Freeze frame	0xc6, "0" "1"	Unfreeze / freeze frame	"0" – unfreeze. "1" – freeze.
Rotate video image	0xc7, "0" "1"	Disable/enable video rotate	"0" – normal video image. "1" – rotated video image.
Soft Power On/Off	0xc8, "0" "1" "2"	Soft power off/on query	"0" – soft power off. "1" – soft power on.
Query video input status	0xc9	Query the status of the primary & pip status	"nn" = input status 2 nd digit = primary status: "0" : invalid "1" : connected to valid RGB "2" : connected to valid composite "3" : connected to valid Svideo "4" : connected to valid YcbCr "5" : connected to valid DVI 1 st digit = PIP input status: "0" : invalid "2" : connected to valid composite "3" : connected to valid Svideo "4" : connected to valid YcbCr
Video de-interlace method	0xca, "0" "1" "r" "R" "2"	De-interlace mode Reset Query	"0" – motion video. "1" – static picture. "2" – normal (non-flicker video mode)
Query BIOS version	0xcb, "0"	Read BIOS version	"nnnn" = BIOS ver. "nn.nn"
Query PCBA number	0xcb, "1"	Read PCBA number	"nnnn" = PCBA number
Query average picture level	0xcc, "0" "1" "2"	Read APL for red channel Read APL for green channel Read APL for blue channel	"nn" = average picture level
Load factory default	0xce	Reset all parameters to default value	"1" - successful.

APPENDIX II – SUPPORTED MODES TABLE

Graphic/Video Modes Supported

Mode	Resolution	Clk [MHz]	Horizontal freq [KHz]	Vertical freq [Hz]	Sync Mode
E1_70	640x350	25.175	31.469	70	Digital Separate Sync
E1_70	640x350	25.175	31.469	70	Sync On Green (with or without serrate pulse)
E1_70	640x350	25.175	31.469	70	Composite Sync (with or without serrate pulse)
E1_85	640x350	31.500	37.861	85	Digital Separate Sync
E1_85	640x350	31.500	37.861	85	Sync On Green (with or without serrate pulse)
E1_85	640x350	31.500	37.861	85	Composite Sync (with or without serrate pulse)
E2_70	640x400	25.175	31.469	70	Digital Separate Sync
E2_70	640x400	25.175	31.469	70	Sync On Green (with or without serrate pulse)
E2_70	640x400	25.175	31.469	70	Composite Sync (with or without serrate pulse)
E2_85	640x400	31.500	37.861	85	Digital Separate Sync
E2_85	640x400	31.500	37.861	85	Sync On Green (with or without serrate pulse)
E2_85	640x400	31.500	37.861	85	Composite Sync (with or without serrate pulse)
T_70	720x400	28.322	31.469	70	Digital Separate Sync
T_70	720x400	28.322	31.469	70	Sync On Green (with or without serrate pulse)
T_70	720x400	28.322	31.469	70	Composite Sync (with or without serrate pulse)
T_85	720x400	35.500	37.927	85	Digital Separate Sync
T_85	720x400	35.500	37.927	85	Sync On Green (with or without serrate pulse)
T_85	720x400	35.500	37.927	85	Composite Sync (with or without serrate pulse)
V_62	736x480	28.200	31.403	62	Digital Separate Sync
V_62	736x480	28.200	31.403	62	Sync On Green (with or without serrate pulse)
V_62	736x480	28.200	31.403	62	Composite Sync (with or without serrate pulse)
V_60	640x480	25.175	31.469	60	Digital Separate Sync
V_60	640x480	25.175	31.469	60	Sync On Green (with or without serrate pulse)
V_60	640x480	25.175	31.469	60	Composite Sync (with or without serrate pulse)
V_67	640x480	31.500	37.500	67	Digital Separate Sync
V_67	640x480	31.500	37.500	67	Sync On Green (with or without serrate pulse)
V_67	640x480	31.500	37.500	67	Composite Sync (with or without serrate pulse)
V_72	640x480	31.500	37.861	72	Digital Separate Sync
V_72	640x480	31.500	37.861	72	Sync On Green (with or without serrate pulse)
V_72	640x480	31.500	37.861	72	Composite Sync (with or without serrate pulse)
V_75	640x480	31.500	37.500	75	Digital Separate Sync
V_75	640x480	31.500	37.500	75	Sync On Green (with or without serrate pulse)
V_75	640x480	31.500	37.500	75	Composite Sync (with or without serrate pulse)
V_85	640x480	36.000	43.269	85	Digital Separate Sync
V_85	640x480	36.000	43.269	85	Sync On Green (with or without serrate pulse)
V_85	640x480	36.000	43.269	85	Composite Sync (with or without serrate pulse)
SV_56	800x600	36.000	35.156	56	Digital Separate Sync
SV_56	800x600	36.000	35.156	56	Sync On Green (with or without serrate pulse)
SV_56	800x600	36.000	35.156	56	Composite Sync (with or without serrate pulse)
SV_60	800x600	40.000	37.879	60	Digital Separate Sync
SV_60	800x600	40.000	37.879	60	Sync On Green (with or without serrate pulse)
SV_60	800x600	40.000	37.879	60	Composite Sync (with or without serrate pulse)
SV_72	800x600	50.000	48.077	72	Digital Separate Sync
SV_72	800x600	50.000	48.077	72	Sync On Green (with or without serrate pulse)
SV_72	800x600	50.000	48.077	72	Composite Sync (with or without serrate pulse)
SV_75	800x600	49.500	46.875	75	Digital Separate Sync
SV_75	800x600	49.500	46.875	75	Sync On Green (with or without serrate pulse)
SV_75	800x600	49.500	46.875	75	Composite Sync (with or without serrate pulse)
SV_85	800x600	56.250	53.674	85	Digital Separate Sync
SV_85	800x600	56.250	53.674	85	Sync On Green (with or without serrate pulse)
SV_85	800x600	56.250	53.674	85	Composite Sync (with or without serrate pulse)

X_60	1024x768	65.000	48.363	60	Digital Separate Sync
X_60	1024x768	65.000	48.363	60	Sync On Green (with or without serrate pulse)
X_60	1024x768	65.000	48.363	60	Composite Sync (with or without serrate pulse)
X_70	1024x768	75.000	56.476	70	Digital Separate Sync
X_70	1024x768	75.000	56.476	70	Sync On Green (with or without serrate pulse)
X_70	1024x768	75.000	56.476	70	Composite Sync (with or without serrate pulse)
X_72	1024x768	75.000	57.515	72	Digital Separate Sync
X_72	1024x768	75.000	57.515	72	Sync On Green (with or without serrate pulse)
X_72	1024x768	75.000	57.515	72	Composite Sync (with or without serrate pulse)
X_75	1024x768	78.750	60.023	75	Digital Separate Sync
X_75	1024x768	78.750	60.023	75	Sync On Green (with or without serrate pulse)
X_75	1024x768	78.750	60.023	75	Composite Sync (with or without serrate pulse)
X_87i	1024x768 43Hz Interaced	44.900	35.522	87	Digital Separate Sync
X_87i	1024x768 43Hz Interaced	44.900	35.522	87	Sync On Green (with or without serrate pulse)
X_87i	1024x768 43Hz Interaced	44.900	35.522	87	Composite Sync (with or without serrate pulse)
X_85	1024x768	94.500	68.677	85	Digital Separate Sync
X_85	1024x768	94.500	68.677	85	Sync On Green (with or without serrate pulse)
X_85	1024x768	94.500	68.677	85	Composite Sync (with or without serrate pulse)
SX_60	1280x1024	108.000	63.981	60	Digital Separate Sync
SX_60	1280x1024	108.000	63.981	60	Sync On Green (with or without serrate pulse)
SX_60	1280x1024	108.000	63.981	60	Composite Sync (with or without serrate pulse)
SX_72	1280x1024	135.000	78.125	72	Digital Separate Sync
SX_72	1280x1024	135.000	78.125	72	Sync On Green (with or without serrate pulse)
SX_72	1280x1024	135.000	78.125	72	Composite Sync (with or without serrate pulse)
SX_75	1280x1024	135.000	79.976	75	Digital Separate Sync
SX_75	1280x1024	135.000	79.976	75	Sync On Green (with or without serrate pulse)
SX_75	1280x1024	135.000	79.976	75	Composite Sync (with or without serrate pulse)
UX_60	1600x1200	112.288	75.000	60	Digital Separate Sync
UX_60	1600x1200	112.288	75.000	60	Sync On Green (with or without serrate pulse)
UX_60	1600x1200	112.288	75.000	60	Composite Sync (with or without serrate pulse)
NTSC S_Video	---	14.318	15.734	60	---
PAL S_Video	---	17.75	15.625	50	---
NTSC Composite Video	---	14.318	15.734	60	---
PAL Composite Video	---	17.75	15.625	50	---

WARRANTY

The products are warranted against defects in workmanship and material for a period of one (1) year from the date of purchase provided no modifications are made to it and it is operated under normal conditions and in compliance with the instruction manual.

The warranty does not apply to:

- Product that has been installed incorrectly, this specifically includes but is not limited to cases where electrical short circuit is caused.
- Product that has been altered or repaired except by the manufacturer (or with the manufacturer's consent).
- Product that has subjected to misuse, accidents, abuse, negligence or unusual stress whether physical or electrical.
- Ordinary wear and tear.

Except for the above express warranties, the manufacturer disclaims all warranties on products furnished hereunder, including all implied warranties of merchantability and fitness for a particular application or purpose. The stated express warranties are in lieu of all obligations or liabilities on the part of the manufacturer for damages, including but not limited to special, indirect consequential damages arising out of or in connection with the use of or performance of the products.

CAUTION

Whilst care has been taken to provide as much detail as possible for use of this product it cannot be relied upon as an exhaustive source of information. This product is for use by suitably qualified persons who understand the nature of the work they are doing and are able to take suitable precautions and design and produce a product that is safe and meets regulatory requirements.

LIMITATION OF LIABILITY

The manufacturer's liability for damages to customer or others resulting from the use of any product supplied hereunder shall in no event exceed the purchase price of said product.

TRADEMARKS

The following are trademarks of Digital View Ltd:

- Digital View
- DVI-1600

CONTACT DETAILS

Digital View has offices in Asia, Europe and USA also an internet site:

ASIA

Digital View Ltd
19 th Floor, Tai Tung Building
8 Fleming Road, Wanchai
Hong Kong

Tel: (852) 2861 3615

Fax: (852) 2520 2987

Sales: hksales@digitalview.com

EUROPE

Digital View Ltd
36 Mortimer Street
London W1W 7RG
UK

Tel: (44) (0) 20 7631 2150

Fax: (44) (0) 20 7436 1299

Sales: uksales@digitalview.com

USA

Digital View Inc.
18440 Technology Drive
Building 130
Morgan Hill,
California, 95037
USA

Tel: (1) 408-782 7773

Fax: (1) 408-782 7883

Sales: ussales@digitalview.com

WEBSITE

www.digitalview.com

Specifications subject to change without notice

Third issue: 1 July, 2005 (DVI-1600.doc)

© Digital View Ltd 2005