



## PC, DVI INTERFACE CONTROLLER FOR TFT PANEL

### Model: ALR-1400v2

Part number : 41758002X-3 or up  
41758002X-5 or up

## INSTRUCTIONS

### CONTENTS

Page:	<b>2. Revision history</b>
	<b>3. Introduction, How to Proceed, Usage Note, Disclaimer</b>
	<b>4. System design</b> – Diagram of a suggested system
	<b>5. Assembly notes</b> – Important information about system elements
	<b>7. Connection &amp; Operation</b> – How to use the controller
	<b>11. Connectors, pinouts &amp; jumpers</b> – Essential connection information
	<b>19. Controller dimensions</b>
	<b>20. Application notes</b>
	<b>22. Troubleshooting</b>
	<b>23. Specifications</b>
	<b>24. Appendix I – Graphic Mode Support Table</b>
	<b>26. Appendix II – RS-232 control protocols</b>
	<b>31. Appendix III – Mapping definition</b>
	<b>33. Appendix IV – Color Auto Adjust</b>
	<b>34. Warranty, Caution &amp; Limitation of Liability, Trademarks</b>
	<b>35. Contact details</b>

**It is essential that these instructions are read and understood before connecting or powering up this controller.**

## Revision History

Date	Rev No.	Page	Summary
30 Sept 2016	1.00	All	First Issue for preliminary version.
11 Nov 2016	2.00	8	- Change brightness hotkey function on "+" / "-" button (same as ALR-1400)
		8	- Add backlight hotkey function on "SEL UP" / "SEL DN" button (same as ALR-1400)
		10	Add Wide Screen Mode function support on OSD menu.
		14	Support three more panel supports - AU Optronics B101EW05 V0 (1280x800) - SHARP LQ064V3DG06 (640x480) - SHARP LQ104V1DG61 (640x480)
		24, 25	Update input mode support table.
		26, 27	- Add more RS-232 commands functions - OSD H position (0x90), OSD V position (0x91), OSD Transparency (0x92), Select OSD language (0x95), Auto Source Seek (0x99), Scaling Mode (0x8c) & Wide Screen Mode Selection (0xd9)
6 Feb 2025	3.00	1&3	- Add P/N 4175800XX-5 for RoHS & REACH version in ordering information.
		8	- Remove 'Function with signal input only' under button control table for 'Menu – turns OSD menu On or Off'.
		14	- Add more panel support : Mitsubishi AA084XE01-CA3 Innolux G150XGE-L04
		27	- Remove 0x92 '+' / '-' command which is a not available function.
		30	- Add Query video input status (0xc9) command

---

## Introduction

Designed for LCD monitor and other flat panel display applications, the ALR-1400v2 controller provides easy to use interface controller for:

- **TFT (active matrix) LCDs with LVDS interface of 1440x900, 1366x768, 1280x1024, 1280x800, 1024x768, 800x600, 640x480 resolution;**
- **Computer video signals of SXGA, XGA, SVGA, VGA standard**
- **Support LVDS or TTL interface panel**

### Ordering information :

Controller	Part number	Ordering part number	Compliance
ALR-1400v2	P/N 41758002X-3	P/N 4175800XX-3	RoHS
ALR-1400v2	P/N 41758002X-5	P/N 4175800XX-5	RoHS & REACH

### HOW TO PROCEED

- Ensure you have all parts & that they are correct, refer to:
  - Connection diagram (separate document for each panel)
  - Connector reference (in following section)
  - Assembly notes
- Check controller switch & jumper settings (errors may damage the panel)
- Prepare the PC
- Connect the parts
- Understand the operation and functions (in following section)

### IMPORTANT USAGE NOTE

This product is for use by system developers and integrators, the manufacturer accepts no liability for damage or injury caused by the use of this product. It is the responsibility of the developer, integrators or other user of this product to:

- Ensure that all necessary and appropriate safety measures are taken.
- Obtain suitable regulatory approvals as may be required.
- Check power settings to all component parts before connection.
- Understand the operation and connectivity requirements of this controller.

### DISCLAIMER

There is no implied or expressed warranty regarding this material.

## SYSTEM DESIGN

A typical LCD based display system utilising this controller is likely to comprise the following:

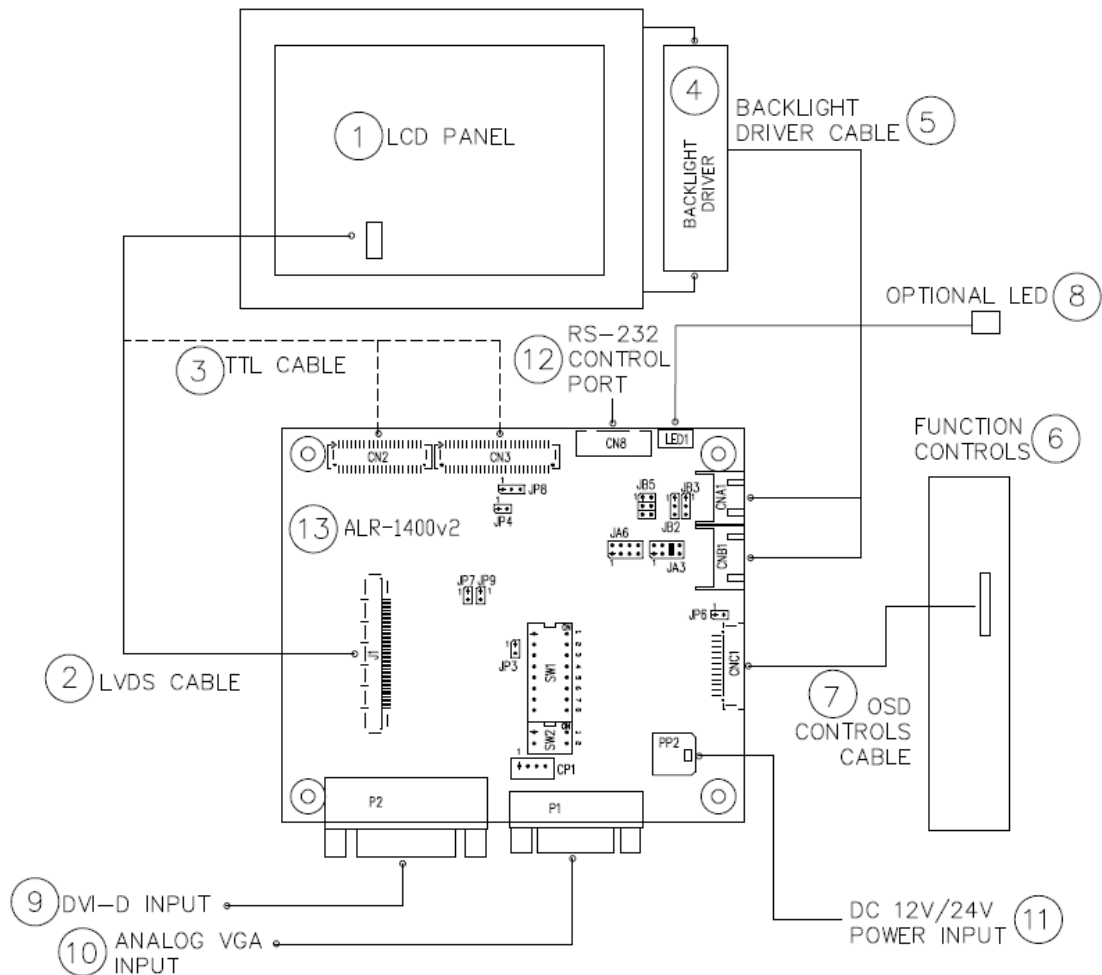

### Summary:

1. LCD panel
2. LVDS cable (for connection with LVDS panel)
3. TTL cable (for connection with TTL panel)
4. Backlight driver (if not built into LCD)
5. Backlight driver cable
6. Function controls
7. Function controls cable
8. Status LED
9. DVI-D input
10. Analog VGA input
11. Power input (12VDC / 24VDC)
12. RS-232 control port
13. LCD controller card, ALR-1400v2

Digital View offers a range of accessories such as listed above, to make up complete display solution.

---

## ASSEMBLY NOTES

This controller is designed for monitor and custom display projects using 1440x900, 1366x768, 1280x1024, 1280x800, 1024x768, 800x600, 640x480 resolution TFT panels with a SXGA, WXGA, XGA, SVGA, VGA signal input. The following provides some guidelines for installation and preparation of a finished display solution.

**Preparation:** Before proceeding it is important to familiarize yourself with the parts making up the system and the various connectors, mounting holes and general layout of the controller. As much as possible connectors have been labeled. Guides to connectors and mounting holes are shown in the following relevant sections.

1. **LCD Panel:** This controller is designed for typical LVDS or TTL interface TFT panels with panel voltage 3.3V or 5V or 12V or 18V LVDS interface. Due to the variation between manufacturers of signal timing and other panel characteristics factory setup and confirmation should be obtained before connecting to a panel. **(NOTE: Check panel power jumper settings before connection)**
  2. **Controller card:** Handle the controller card with care as static charge may damage electronic components.
  3. **LVDS signal cable :** In order to provide a clean signal it is recommended that LVDS signal cables are no longer than 46cm (18 inches). If loose wire cabling is utilized these can be made into a harness with cable ties. Care should be taken when placing the cables to avoid signal interference. Additionally it may be necessary in some systems to add ferrite cores to the cables to minimize signal noise.
  4. **TTL signal cable:** In order to provide a clean signal it is recommended that LCD signal cables are no longer than 33cm (13 inches). If loose wire cabling is utilized these can be made into a harness with cable ties. Care should be taken when placing the cables to avoid signal interference. Additionally it may be necessary in some systems to add ferrite cores to the cables to minimize signal noise.
  5. **Backlight driver:** This will be required for the backlight of an LCD, some LCD panels have an built in backlight driver. As panels may have 1 or more backlight tubes and the power requirements for different panel models backlights may vary it is important to match the backlight driver in order to obtain optimum performance. See page 20 for the Application notes "Backlight driver connection section for more informations.
  6. **Backlight driver Cables:** Different backlight driver models require different cables and different pin assignment. Make sure correct cable pin out to match the backlight driver. Using wrong cable pin out may damage the backlight driver.
  7. **Function Controls:** The following section discusses the controls required and the section on connectors provides the detail. The controls are minimal: On/Off, Backlight Brightness (depends on backlight driver), OSD (5 momentary buttons) analog VR type or (8 momentary buttons) digital type.
  8. **Function controls cable:** The cables to the function switches should be of suitable quality and length so that impedance does not affect performance. Generally lengths up to 1 metre (3 feet) should be acceptable.
  9. **DVI-D Input Cable :** Plug the DVI-D cable to the connector P2 on the controller board
  10. **Analog VGA Input Cable:** As this may affect regulatory emission test results and the quality of the signal to the controller, a suitably shielded cable should be utilized.
- **Power Input:** 12V / 24V DC is required, this should be a regulated supply. Although the controller provides power regulation for the LCD power this does not relate to the power supplied to the backlight driver. If an unregulated power supply is provided to an backlight driver any fluctuations in power may affect operation, performance and lifetime of the backlight driver and or backlight tubes. 24VDC input is required when the panel output voltage is 18VDC. Please refer to page 12-13 for proper jumper settings.
  - **Power Safety:** Note that although only 12VDC / 24VDC is supplied as 'power-in' a backlight driver for panel backlighting produces significantly higher voltages (the backlight driver does not connect to the ground plane). We strongly advise appropriate insulation for all circuitry.
  - **EMI:** Shielding will be required for passing certain regulatory emissions tests. Also the choice of external Controller to PC signal cable can affect the result.
  - **Ground:** The various PCB mounting holes are connected to the ground plane.
  - **Servicing:** The board is not user serviceable or repairable. Warranty does not cover user error in connecting up to the controller and is invalidated by unauthorized modification or repairs.
  - **Controller Mounting:** It is recommended that a clearance of at least 10mm is provided above and 5mm below the controller when mounted. Additionally consideration should be given to:
    - Electrical insulation.
    - Grounding.
    - EMI shielding.
    - Cable management. Note: It is important to keep panel signal cables apart from the backlight drivers & backlight cables to prevent signal interference.
    - Heat & Ventilation: Heat generated from other sources, for example the backlight of a very high brightness panel may generate significant heat which could adversely affect the controller.

Specifications subject to change without notice

- Other issues that may affect safety or performance.
- **PC Graphics Output:** A few guidelines:
  - Signal quality is very important, if there is noise or instability in the PC graphics output this may result in visible noise on the display.
  - Refer to graphics modes table in specifications section for supported modes.
  - Non-interlaced & interlaced video input is acceptable.

**IMPORTANT: Please read the Application Notes section for more information.**

---

## CONNECTION & OPERATION

**CAUTION:** Never connect or disconnect parts of the display system when the system is powered up as this may cause serious damage.

### CONNECTION

Connection and usage is quite straight forward (it is useful to have the relevant connection diagram available at this time):

1. **LCD panel & Backlight driver:** Connect the backlight driver (if it is not built-in the panel) to the CCFT lead connector of the LCD panel.
2. **LVDS type panels:** Plug the LVDS signal cable direct to J1 (if necessary). Insert the panel end of the cable to the LCD panel connector.
3. **TTL type panels:** Plug the signal cables direct to CN2 or CN3. Plug the other end of cables to the LCD connector board (if connector board is required, otherwise the signal can be direct plug to the LCD panel connector). Then plug the board connector to the LCD panel connector.
4. **Backlight driver & Controller:** Plug the backlight driver cable to CNB1 and CNA1 (if necessary). Plug another end to the connector on the backlight driver.
5. **Function switch & Controller:** Plug the OSD switch mount cable to CNC1 on the controller board and another to the OSD switch mount.
6. **LED & Controller:** Plug in a 3-way with dual color LED to connector LED1 on the controller board.
7. **Jumpers :** Check all jumpers are set correctly. Details referring the connection diagram at <http://www.digitalview.com/controllers/csg.php>
8. **Jumpers & Backlight driver & Panel voltage:** Particularly pay attention to the settings of JA3, JA6, JB2, JB3. JB2 & JB3 are used for backlight driver control (read backlight driver specification and information on the jumper table to define the correct settings). JA3 & JA6 are used for panel voltage input (read panel specification and information on the jumper table to define the correct settings).
9. **DVI cable :** Plug the DVI-D cable to the connector P2 on the controller board.
10. **VGA cable & Controller:** Plug the VGA cable to the connector P1 on the controller board.
12. **Power supply & Controller:** Plug the DC 12V / 24V power in to the connector PP2. You can consider to use DigitalView mating power cable P/N 426013800-3, 160mm.
13. **Power on:** Switch on the controller board and panel by using the OSD switch mount.

**CAUTION:** Never connect or disconnect parts of the display system when the system is powered up as this may cause serious damage.

LED status :

State	LED color
No signal & backlight off	RED
With signal & backlight on	GREEN

General:

- If you are using supplied cables & accessories, ensure they are correct for the model of panel and controller.
- If you are making your own cables & connectors refer carefully to both the panel & backlight driver specifications and the section in this manual, "Connectors, Pinouts & Jumpers" to ensure the correct pin to pin wiring.

### PC SETTINGS

The controller has been designed to take a very wide range of input signals however to optimize the PC's graphics performance we recommend choosing 60Hz vertical refresh rate – this will not cause screen flicker.

### OPERATION

Once the system has been connected and switched on there are a number of functions available to adjust the display image as summarized in the following sections. The settings chosen will be saved for each mode independently.

## LCD DISPLAY SYSTEM SETTINGS

NOTE: By way of explanation the following refers to a set of sample buttons that may be obtained as an option. In addition to power on/off and connection for backlight brightness the controller provides an On Screen Display of certain functions which are controlled by 5 momentary type buttons (analog VR type) or 8 momentary type buttons (digital type):

Controls	Analog VR type	Digital type
On/Off – turns controller board power on	VR toggle switch	On/Off button
Brightness – controls backlight brightness	Rotary VR	Brightness +/- buttons
Menu – turns OSD menu On or Off (it will auto time off)	Menu button	Menu button
Select – Select function / Confirm (under OSD menu on state)	SEL DN	SEL DN
Move up / down to select OSD menu function (under OSD menu on state)	SEL UP	SEL UP
+ – increase the setting / moves the selector to the next function (under OSD menu on state)	+	+
- - decrease the setting / moves the selector to the previous function (under OSD menu on state)	-	-
Reset to Factory Defaults	Press and hold SEL DN button, then power on the controller	Press and hold SEL DN button, then power on the controller
Direct access key for Brightness level increase (under OSD menu off state)	+	+
Direct access key for Brightness level decrease (under OSD menu off state)	-	-
Direct access key for Backlight Brightness increase* (under OSD menu off state)	SEL UP	SEL UP
Direct access key for Backlight Brightness decrease* (under OSD menu off state)	SEL DN	SEL DN

\* No OSD menu display when adjusting the "Backlight" hotkey function

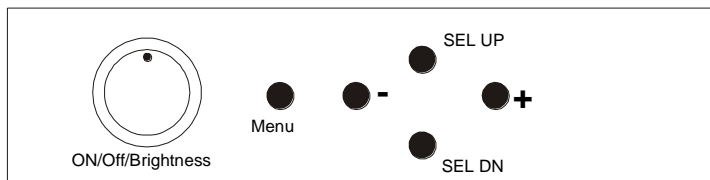

Analog VR type

**12V / 24VDC power input :**  
Analog 10K VR Type OSD  
switch mount uses  
P/N 410680550-3 or up

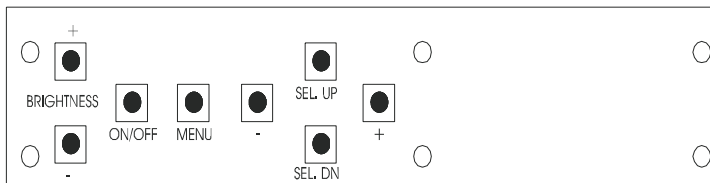













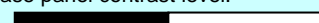
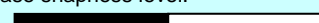
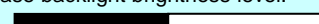



Digital type



**12V / 24VDC power input :**  
Digital 10K Type OSD  
switch mount uses  
P/N 416100520-3 or up

**12VDC power input :**  
Digital 10K Type OSD  
switch mount uses  
P/N 416100510-3



## OSD Functions

 <b>Picture</b>	
<b>Brightness</b>	Increase/decrease brightness level. Press – or + ( -  + ) Total : 100 steps
<b>Contrast</b>	Increase/decrease panel contrast level. Press – or + ( -  + ) Total : 100 steps
<b>Sharpness</b>	Increase/decrease sharpness level. Press – or + ( -  + ) Total : 7 steps
<b>Backlight</b>	Increase/decrease backlight brightness level. Press – or + ( -  + ) Total : 100 steps
<b>Invert</b>	B/L Invert : Invert for the backlight brightness
 <b>Display</b>	
<b>H. Position*</b>	Use +/- to move the image horizontally. Press – or + ( -  + ) Total : 100 steps
<b>V. Position*</b>	Use +/- to move the image vertically. Press – or + ( -  + ) Total : 100 steps
<b>Clock*</b>	Adjust the image horizontal size. Press – or + ( -  + ) Total : 100 steps
<b>Phase*</b>	Fine tune the data sampling position (adjust image quality) Press – or + ( -  + ) Total : 100 steps
<b>Aspect</b>	WIDE : Scaling format to Fill screen 4:3 : Scaling format in 4:3
 <b>Color</b>	
<b>Gamma</b>	0.4 / 0.6 / 1.0 / 1.6 / 2.2 : Adjust Gamma settings
<b>Color Temperature ▶</b>	(Adjust the warmness of the image displayed. The higher temperature the coolest image looks like. The lower temperature the warmest image looks like.)
<b>User</b>	Adjust red color level Press – or + ( -  + ) Total : 100 steps Adjust green color level Press – or + ( -  + ) Total : 100 steps Adjust blue color level Press – or + ( -  + ) Total : 100 steps  Press SEL UP/DN button to select item
<b>4200K</b>	Set the color temperature to 4200K
<b>5000K</b>	Set the color temperature to 5000K
<b>6500K</b>	Set the color temperature to 6500K
<b>7500K</b>	Set the color temperature to 7500K
<b>9300K</b>	Set the color temperature to 9300K
 <b>OSD Setting</b>	
<b>Language</b>	Press SEL UP/DN button to select item  English / French / Spanish
<b>OSD H. POS.</b>	Adjust OSD menu Horizontal position. Press – or + ( -  + ) Total : 100 steps
<b>OSD V. POS.</b>	Adjust OSD menu Vertical position. Press – or + ( -  + ) Total : 100 steps
<b>OSD TIMER</b>	OSD Timeout : 0 / 10 / 20 / 30 / 40 / 50 / 60 seconds (Always on when set to 0) Press – or + ( -  + )
<b>Transparency</b>	Set the OSD menu transparency level : 0 / 25 / 50 / 75 / 100 Press – or + ( -  + ) Total : 5 steps

 <b>Reset</b>	
<b>Image Auto Adjust*</b>	Auto adjust the positions, phase, frequency
<b>Color Auto Adjust*</b>	Auto color calibration [See Appendix IV]
<b>Factory Reset</b>	OSD Timeout : 0 / 10 / 20 / 30 / 40 / 50 / 60 seconds (Always on when set to 0) Press – or + (- <input type="text"/> +)
 <b>Others</b>	
<b>Signal Source</b>	DVI : Select input source to DVI VGA : Select input source to VGA
<b>Auto Source Seek</b>	ON : Auto source select always enable OFF : Disable auto source select function
<b>B/L Control</b>	DA or PWM : Selection for voltage level dimming control / PWM dimming control
<b>PWM FREQ</b>	Backlight frequency 100 ~ 440 in a step of 20
<b>Wide screen mode*</b>	Select the input mode (1280 / 1360 / 1366 / 1368) to recognize and display the correct input signal information display on the OSD menu. 1280x768 1360x768 1366x768 1368x768

\* Function in VGA mode only

Items marked ▶ have sub menus.  
Exit the OSD menu to save the setting chosen

## CONNECTORS, PINOUTS & JUMPERS

The various connectors are:

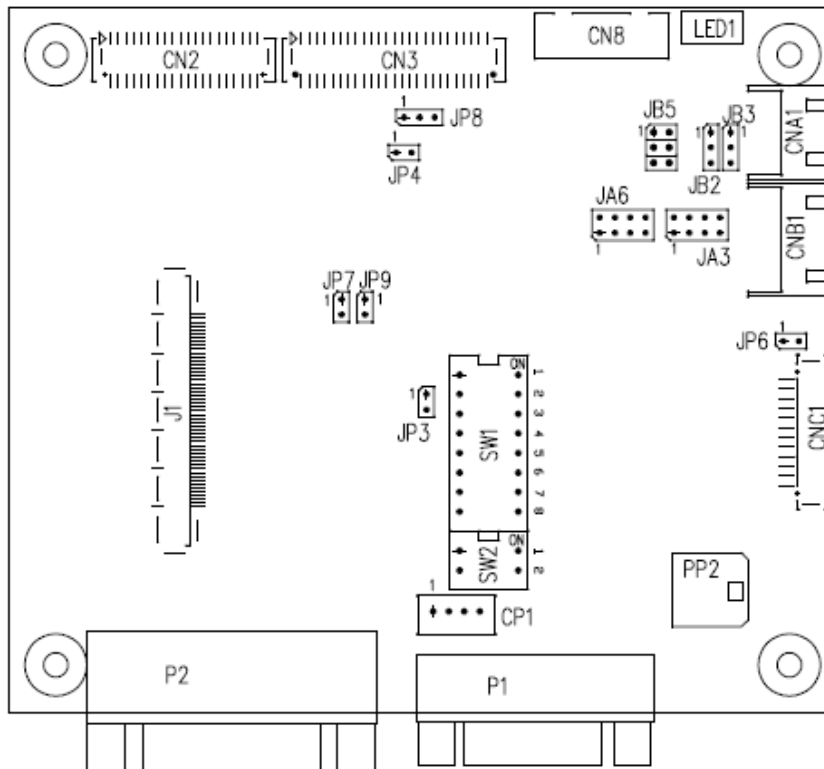

### Summary: Connectors

Ref	Purpose	Description
J1	LVDS Panel Signal	STARCONN : 115E51-0000RA-M3-R (Matching type : STARCONN 107D51-000001-00 or compaible)
CN2	TTL Panel Signal	Hirose 40-pin, DF20G-40DP-1V (Mating type : DF20A-40DS-1C)
CN3	TTL Panel Signal	Hirose 50-pin, DF20G-50DP-1V (Mating type : DF20A-50DS-1C)
CN8	Serial control (for firmware programming or RS-232 control use only)	JST 6-way, B6B-XH-A compatible (Mating type : XHP-6 or compatible)
CNA1	Auxiliary Power Output	JST 4-way, S4B-XH-A compatible (Mating type : XHP-4 or compatible)
CNB1	Backlight control connector	JST 5-way, S5B-XH-A compatible (Mating type : XHP-5 or compatible)
CNC1	OSD controls	Hirose DF13A-12P-1.25H compatible (Mating type : DF13-12S-1.25C) (Matching OSD switch mount cable P/N 426122200-3 (150mm) or 426122210-3 (250mm))
CP1	Internal programming connector	JST PHD-4 compatible (Mating type : PHR-4 or compatible)
LED1	Dual color status LED connector	JST 3-way, B3B-XH-A compatible (Mating type : XHP-3 or compatible)
P1	VGA input	DB-15 way high density 3 row
P2	DVI-D input	DVI-D connector
PP2	Main Input Power	Molex 43650-0200 compatible (Mating type : Molex 43645-0200 compatible) (Matching power cable : P/N 426013800-3)







Summary: Jumpers setting

Ref	Purpose	Note
JA3	Panel power voltage select	See panel voltage setting table 1 <b>CAUTION:</b> Incorrect setting will cause panel damage
JA6	Panel power voltage select	See panel voltage setting table 1 <b>CAUTION:</b> Incorrect setting will cause panel damage
JB2	Backlight on/off control – signal level	1-2 = On/Off control signal 'High' = +3.3V 2-3 = On/Off control signal 'High' = +5V Open = On/Off control signal 'High' = Open collector <b>CAUTION:</b> Incorrect setting can damage backlight driver.
JB3	Backlight on/off control – polarity	1-2 = control signal 'high' = CCFT ON 2-3 = control signal 'low' = CCFT ON
JB5	Backlight control type selection	1-2 = VR/Digital switch mount control 3-4 = Analog backlight brightness controlled by RS-232 – voltage range 0~5V 5-6 = PWM (Pulse Width Modulation) brightness
JP3	Reserved	Default Open
JP4	LVDS or TTL panel selection	Close = LVDS panel Open = TTL panel
JP6	Input power control	Short = External switch control Open = Switch mount control
JP7	Reserved	Reserved for internal programming use (Always 1-2 closed)
JP8	Clock phase (Analog RGB)	1-2 = Normal 2-3 = Invert
JP9	Reserved	1-2 = Default
SW1	Panel selection	See table below
SW2	Panel selection	See table below

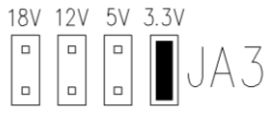
Table 1 : Panel voltage setting table :

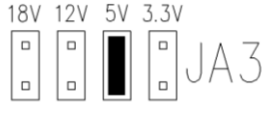
Input voltage via PP2	Panel Voltage	JA3	JA6	Jumper on board
12VDC	3.3V	3V3 closed	1-3 & 2-4	
	5V	5V closed	1-3 & 2-4	
	12V	OPEN	5-7 & 6-8	

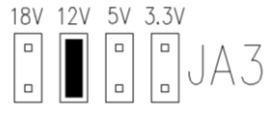
CAUTION: Incorrect setting can damage panel & controller

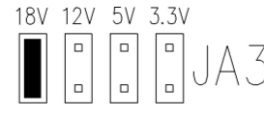
Input voltage via PP2	Panel Voltage	JA3	JA6	Jumper on board
24VDC**	3.3V	3V3 closed	1-3 & 2-4	 
	5V	5V closed	1-3 & 2-4	 
	12V	12V closed	3-5 & 4-6	 
	18V	18V closed	3-5 & 4-6	 

**\*\* Please make sure the backlight power must support 24V supply. Because CNA1 pin 1 and CNB1 pin 2 will output 24VDC if input 24VDC via PP2.**

JA3 & JA6 location on board : (Please pay attention to the jumper settings on JA3 & JA6 which are red in color on board)

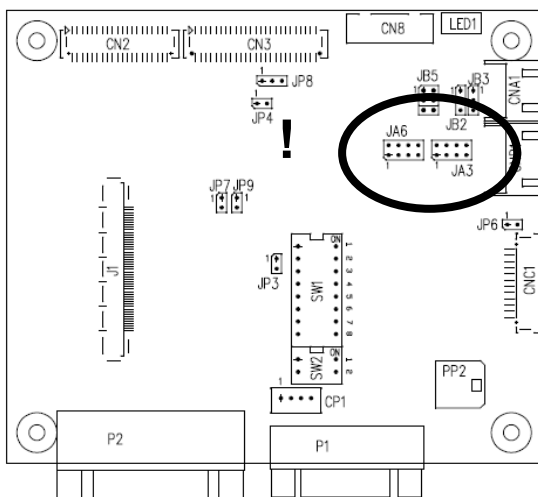

Specifications subject to change without notice

### DIP Switch selection – SW1

Pos #1	Pos #2	Pos #3	Pos.#4	Description	Panel resolution
<b>For SXGA panel</b>					
ON	OFF	OFF	ON	Hannstar HSD170ME13-A06 AU Optronics G190EG01v1	1280x1024 1280x1024
OFF	ON	ON	OFF	LG LM190E09-TLD1 <sup>(1)</sup>	1280x1024
<b>For WXGA panel</b>					
ON	OFF	OFF	OFF	AU Optronics G156XW01 V1	1366x768
<b>For XGA panel</b>					
ON	ON	OFF	ON	Fujitsu FLC38XGC6V-06 Mitsubishi AA084XE01-CA3	1024x768
OFF	OFF	ON	ON	AU Optronics M150XN07 v2	1024x768
OFF	OFF	ON	ON	NEC NL10276BC30-18C NEC NL10276BC20-18	1024x768 1024x768
OFF	ON	ON	OFF	Kyocera TCG121XGLPBPNN-AN40 <sup>(1)</sup>	1024x768
ON	OFF	ON	OFF	AU Optronics G121XN01.0 <sup>(1)</sup>	1024x768
OFF	ON	ON	OFF	Innolux G150XGE-L04 <sup>(1)</sup>	1024x768
<b>For SVGA panel</b>					
OFF	OFF	ON	OFF	Sharp LQ121S1DG11 NEC NL8060BC26-35F Sharp LQ121S1DG81	800x600 800x600 800x600
<b>For VGA / WVGA panel</b>					
ON	OFF	OFF	OFF	Sharp LQ064V3DG06	640x480
ON	OFF	OFF	OFF	Sharp LQ64D343	640x480
ON	OFF	ON	OFF	Sharp LQ104V1DG11	640x480
ON	ON	OFF	OFF	Sharp LQ104V1DG61	640x480
OFF	ON	OFF	OFF	Mitsubishi AA104VJ02	640x480
ON	OFF	OFF	ON	Kyocera T51750GD065J-LW-BGN <sup>(1)</sup>	640x480
<b>Others</b>					
OFF	OFF	ON	ON	Hannstar HSD190MGW1 A00	1440x900
OFF	ON	OFF	OFF	AU Optronics B101EW05 V0	1280x800
OFF	OFF	ON	OFF	LG LM171WX3-TLB2	1440x900

(1) Effective on V1.06.00 version or up.

For additional and recent added panels, see ALR-1400v2 panel support table at <http://www.digitalview.com/controllers/csg.php>

Pos #5	Pos #6	Pos #7	Description
OFF	ON	OFF	SXGA
ON	ON	OFF	WXGA
OFF	OFF	ON	XGA
ON	OFF	ON	SVGA
OFF	ON	ON	VGA / WVGA
ON	ON	ON	Others

SW1 Pos 8 = Reserved.

### DIP switch selection – SW2

Pos. #	Function	Description
1	Panel pixel format	OFF : Double Pixel ON : Single Pixel
2	LVDS data mapping select	ON : Mapping A (LVDS panel) OFF : Mapping B (LVDS panel) Please adjust to get the correct picture. See as Appendix II for details of mapping A and B. Set ON for TTL panels.

The most current list can be found the controller solution generator at <http://www.digitalview.com/controllers/csg.php>

### Support "Resolution default by EDID" for different resolution panel.

The controller will set the preferred timing based off the dip switch setting (SW1 position 1-7) selection, but also be able to go higher to 1680x1050. For example, if the panel is a 1024x768 and the dip switch setting are set for 1024x768. The preferred EDID resolution should be 1024x768. It should also have the capability to set the max resolution to 1680x1050.

**CN2 – Panel connector: HIROSE DG20G-40DP-1V (Matching type : DF20A-40DS-1C)**

PIN	SYMBOL	DESCRIPTION
1	GND	Ground
2	GND	Ground
3	NC	No connection
4	NC	No connection
5	ER0	Even data bit R0
6	ER1	Even data bit R1
7	ER2	Even data bit R2
8	ER3	Even data bit R3
9	ER4	Even data bit R4
10	ER5	Even data bit R5
11	ER6	Even data bit R6
12	ER7	Even data bit R7
13	GND	Ground
14	GND	Ground
15	NC	No connection
16	NC	No connection
17	EG0	Even data bit G0
18	EG1	Even data bit G1
19	EG2	Even data bit G2
20	EG3	Even data bit G3
21	EG4	Even data bit G4
22	EG5	Even data bit G5
23	EG6	Even data bit G6
24	EG7	Even data bit G7
25	GND	Ground
26	GND	Ground
27	NC	No connection
28	NC	No connection
29	EB0	Even data bit B0
30	EB1	Even data bit B1
31	EB2	Even data bit B2
32	EB3	Even data bit B3
33	EB4	Even data bit B4
34	EB5	Even data bit B5
35	EB6	Even data bit B6
36	EB7	Even data bit B7
37	GND	Ground
38	GND	Ground
39	CLK	Dot clock
40	NC	No connection

**CN3 – Panel connector: HIROSE DF20G-50DP-1V (Matching type : DF20A-50DS-1C)**

PIN	SYMBOL	DESCRIPTION
1	GND	Ground
2	GND	Ground
3	NC	No connection
4	NC	No connection
5	OR0	Odd data bit R0
6	OR1	Odd data bit R1
7	OR2	Odd data bit R2
8	OR3	Odd data bit R3
9	OR4	Odd data bit R4
10	OR5	Odd data bit R5
11	OR6	Odd data bit R6
12	OR7	Odd data bit R7
13	GND	Ground
14	GND	Ground
15	NC	No connection
16	NC	No connection
17	OG0	Odd data bit G0
18	OG1	Odd data bit G1
19	OG2	Odd data bit G2
20	OG3	Odd data bit G3
21	OG4	Odd data bit G4
22	OG5	Odd data bit G5
23	OG6	Odd data bit G6
24	OG7	Odd data bit G7
25	GND	Ground

26	GND	Ground
27	NC	No connection
28	NC	No connection
29	OB0	Odd data bit B0
30	OB1	Odd data bit B1
31	OB2	Odd data bit B2
32	OB3	Odd data bit B3
33	OB4	Odd data bit B4
34	OB5	Odd data bit B5
35	OB6	Odd data bit B6
36	OB7	Odd data bit B7
37	GND	Ground
38	GND	Ground
39	VS	Vertical sync
40	CLK	Dot clock
41	HS	Horizontal sync
42	DE	Display enable
43	PWR	Power down control signal (5v TTL)
44	VLCD	Panel power supply (3,3V/5V) (selected by JA3 & JA6)
45	VLCD	Panel power supply (3,3V/5V) (selected by JA3 & JA6)
46	VLCD	Panel power supply (3,3V/5V) (selected by JA3 & JA6)
47	NC	No connection
48	VLCD12/18	+12V/18V panel supply (selected by JA3 & JA6)
49	VLCD12/18	+12V/18V panel supply (selected by JA3 & JA6)
50	VLCD12/18	+12V/18V panel supply (selected by JA3 & JA6)

**CN8 – RS-232 serial control: JST B6B-XH-A compatible (Mating type : XHP-6 or compatible)**

PIN	SYMBOL	DESCRIPTION
1	SDATA	Reserved
2	SCLK	Reserved
3	VCC	+5V
4	TXD	RS-232 Tx data
5	GND	Ground
6	RXD	RS-232 Rx data

**CNA1 - Auxiliary power output: JST S4B-XH-A compatible (Mating type : XHP-4 or compatible)**

PIN	SYMBOL	DESCRIPTION
1	AUX POWER	+12V DC, 500mA max / +24V DC, 3A max
2	GND	Ground
3	GND	Ground
4	AUX 5V	+5V DC, 500mA max

**CNB1 – Backlight control connector: JST S5B-XH-A compatible (Mating type : XHP-5 or compatible)**

PIN	SYMBOL	DESCRIPTION
1	GND	Ground
2	VBKL	Backlight power supply, +12VDC / +24V DC, 3A max
3	BLCTRL	Backlight On/Off control signal (refer to JB2 & JB3)
4	BVR_WIP	Backlight brightness VR pin WIP
5	BVR_A	Backlight brightness VR pin A

**CNC1 – OSD switch mount control, Hirose DF13-12P-1.25H compatible (Mating type : DF13-12S-1.25C or compatible)**

PIN	SYMBOL	DESCRIPTION
1	PSWIN	Power button A
2	SW_ON	Power button B
3	BVR_A	Backlight Brightness VR pin A
4	BVR_WIP	Backlight Brightness R pin WIP
5	BVR_B	Backlight Brightness VR pin B (470 ohm resistor to +5V Vcc)
6	GND	Ground
7	MENU	OSD menu
8	-/LEFT	OSD -/Left
9	+/RIGHT	OSD +/Right
10	SEL_DN	OSD Select down
11	SEL_UP	OSD Select up
12	NC	No connection

The VR for brightness depends on the backlight driver. The main power load for On/Off is handled by a relay on the controller.



**CNC1 – OSD switch mount control, Hirose DF13A-12P-1.25H compatible (Mating type : DF13-12S-1.25C)**

PIN	SYMBOL	DESCRIPTION
1	PSWIN	Power button A
2	SW_ON	Power button B
3	BVR_A	Backlight Brightness VR pin A
4	BVR_WIP	Backlight Brightness R pin WIP
5	BVR_B	Backlight Brightness VR pin B (470 ohm resistor to +5V Vcc)
6	GND	Ground
7	MENU	OSD menu
8	-/LEFT	OSD -/Left
9	+ /RIGHT	OSD +/Right
10	SEL_DN	OSD Select down
11	SEL_UP	OSD Select up
12	NC	No connection

**J1 – LVDS output connector: STARCONN : 115E51-0000RA-M3-R (Matching type : STARCONN 107D51-000001-00 or compaible)**

PIN	SYMBOL	DESCRIPTION
1	VLCD_HV	Panel power supply (+12V / 18V) (selected by JA3 & JA6)
2	VLCD_HV	Panel power supply (+12V / 18V) (selected by JA3 & JA6)
3	VLCD_HV	Panel power supply (+12V / 18V) (selected by JA3 & JA6)
4	VLCD_HV	Panel power supply (+12V / 18V) (selected by JA3 & JA6)
5	VLCD_HV	Panel power supply (+12V / 18V) (selected by JA3 & JA6)
6	VLCD_LV	Panel power supply (3,3V/5V) (selected by JA3 & JA6)
7	VLCD_LV	Panel power supply (3,3V/5V) (selected by JA3 & JA6)
8	VLCD_LV	Panel power supply (3,3V/5V) (selected by JA3 & JA6)
9	VLCD_LV	Panel power supply (3,3V/5V) (selected by JA3 & JA6)
10	VLCD_LV	Panel power supply (3,3V/5V) (selected by JA3 & JA6)
11	GND	Ground
12	GND	Ground
13	GND	Ground
14	GND	Ground
15	GND	Ground
16	NC	No function
17	NC	No function
18	NC	No function
19	NC	No function
20	GND	Ground
21	GND	Ground
22	NC	No function
23	NC	No function
24	LVDS_OUT1_A3+	Positive differential LVDS data bit A3
25	LVDS_OUT1_A3-	Negative differential LVDS data bit A3
26	GND	Ground
27	LVDS_OUT1_AC+	Positive LVDS clock for A channel
28	LVDS_OUT1_AC-	Negative LVDS clock for A channel
29	GND	Ground
30	LVDS_OUT1_A2+	Positive differential LVDS data bit A2
31	LVDS_OUT1_A2-	Negative differential LVDS data bit A2
32	LVDS_OUT1_A1+	Positive differential LVDS data bit A1
33	LVDS_OUT1_A1-	Negative differential LVDS data bit A1
34	LVDS_OUT1_A0+	Positive differential LVDS data bit A0
35	LVDS_OUT1_A0-	Negative differential LVDS data bit A0
36	GND	Ground
37	NC	No function
38	NC	No function
39	LVDS_OUT1_B3+	Positive differential LVDS data bit B3
40	LVDS_OUT1_B3-	Negative differential LVDS data bit B3
41	GND	Ground
42	LVDS_OUT1_BC+	Positive LVDS clock for B channel
43	LVDS_OUT1_BC-	Negative LVDS clock for B channel
44	GND	Ground
45	LVDS_OUT1_B2+	Positive differential LVDS data bit B2
46	LVDS_OUT1_B2-	Negative differential LVDS data bit B2
47	LVDS_OUT1_B1+	Positive differential LVDS data bit B1
48	LVDS_OUT1_B1-	Negative differential LVDS data bit B1
49	LVDS_OUT1_B0+	Positive differential LVDS data bit B0
50	LVDS_OUT1_B0-	Negative differential LVDS data bit B0
51	GND	Ground

**LED1 – Dual color Status LED connector: JST 3-way, B3B-XH-A compatible (Mating type : XHP-3 or compatible)**

PIN	DESCRIPTION
1	Green LED pin (anode)
2	LED pin common (cathode)
3	Red LED pin (anode)

**P1 - Analog VGA input – DB-15 way high density 3 row**

PIN	SYMBOL	DESCRIPTION
1	PCR	Red, analog
2	PCG	Green, analog
3	PCB	Blue analog
4	ID2	Reserved for monitor ID bit 2 (grounded)
5	DGND	Digital ground
6	AGND	Analog ground red
7	AGND	Analog ground green
8	AGND	Analog ground blue
9	DDC_5V	+5V power supply for DDC (optional)
10	DGND	Digital ground
11	ID0	Reserved for monitor ID bit 0 (grounded)
12	DDC_SDA	DDC serial data
13	HS_IN	Horizontal sync or composite sync, input
14	VS_IN	Vertical sync, input
15	DDC_SCL	DDC serial clock

**P2 – DVI-D input**

PIN	SYMBOL	DESCRIPTION
1	/RX2	TMDS Data 2-
2	RX2	TMDS Data 2+
3	GND	Digital Ground
4	NC	No connection
5	NC	No connection
6	DVI_DDC_CLK	DDC Clock
7	DVI_DDC_DAT	DDC Data
8	DVI_VS_IN	Analog vertical Sync
9	/RX1	TMDS Data 1-
10	RX1	TMDS Data 1+
11	GND	Digital Ground
12	NC	No connection
13	NC	No connection
14	DVI_DDC_5V	+5V power supply for DDC (optional)
15	GND	Ground (+5, Analog H/V Sync)
16	NC	No connection
17	/RX0	TMDS Data 0-
18	RX0	TMDS Data 0+
19	GND	Digital Ground
20	NC	No connection
21	NC	No connection
22	GND	Digital Ground
23	RXC	TMDS Clock+
24	/RXC	TMDS Clock-
25	NC	No connection
26	NC	No connection

**PP2 - Power supply Molex 43650-0200 compatible (Mating type : Molex 43645-0200 compatible)**

PIN	DESCRIPTION
1	+12VDC 5A max / +24VDC 5A max
2	Ground

## CONTROLLER DIMENSIONS

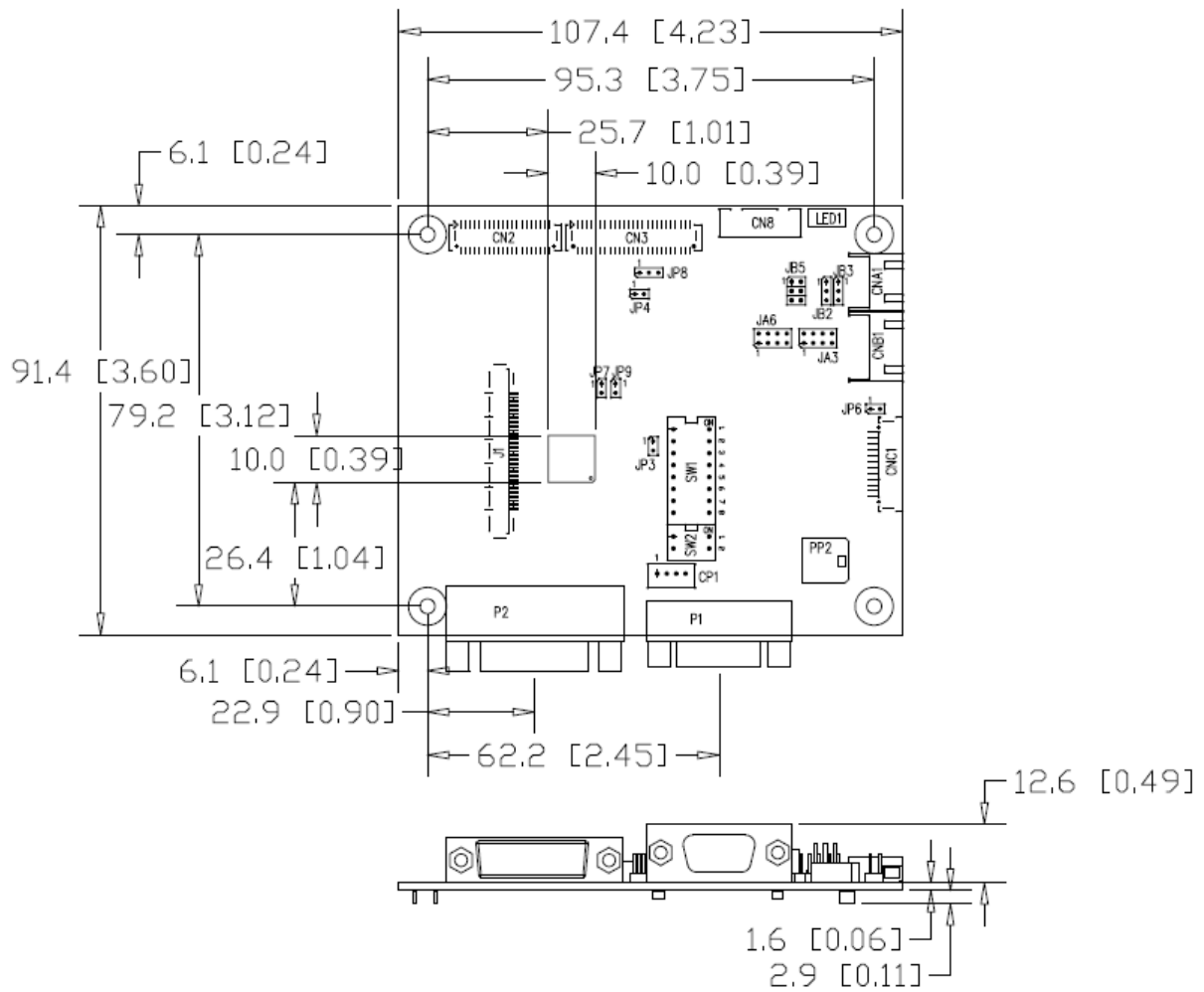

The maximum thickness of the controller is 15.8mm (measured from bottom of PCB to top of components, including any underside components & leads). We recommend clearances of:

- 5mm from bottom of PCB - if mounting on a metal plate we also recommend a layer of suitable insulation material is added to the mounting plate surface.
- 10mm above the components
- 3-5mm around the edges

Any of the holes shown above can be used for mounting the PCB, they are 3.2mm in diameter.

**CAUTION: Ensure adequate insulation is provided for all areas of the PCB with special attention to high voltage parts such as the backlight driver.**

## APPLICATION NOTES

### USING THE CONTROLLER WITHOUT BUTTONS ATTACHED

This is very straightforward by following the steps below :

- Firstly setup the controller/display system with the buttons. With controls attached and display system active make any settings for colour and image position as required then switch everything off.
- Use a jumper to close JP6 jumper, this will fix the board On.
- Refer to backlight driver specifications for details as to fixing brightness to a desired level, this may require a resistor, an open circuit or closed circuit depending on backlight driver.

### BACKLIGHT DRIVER CONNECTION

There are potentially 3 issues to consider with backlight driver connection:

- Power
- Enable
- Brightness

Please read the following sections for a guide to these issues.

**Backlight Power:** As per the table for CNB1 pin 1 is ground and pin 2 provides DC12V/ 24V DC . This should be matched with the backlight driver specification: see table.

#### CNB1

PIN	DESCRIPTION
1	Ground
2	+12VDC / 24VDC

Remark: For higher power backlight driver, more current (for 12V / 24V) can be taken from CNA1 pin 1. Maximum current drawn on CNA1 pin 1 and CNB1 pin 2 is 3A (24V) / 3A(12V)

**Enable:** This is a pin provided on some backlight drivers for On/Off function and is used by this panel controller for VESA DPMS compliance. If the backlight driver does not have an enable pin or the enable pin is not used then DPMS will not be operational. Pin 3 should be matched to the backlight drivers specification for the 'enable' or 'disable' pin.

#### CNB1

PIN	DESCRIPTION
3	Enable

Further, jumpers JB2 & JB3 should be set to match the backlight drivers specification for the enable pin power and High or Low setting: see table.

Ref	Purpose	Note
JB2	Backlight enable voltage	1-2 H = 3.3V, 2-3 H = 5V (Vcc), OPEN H = open collector
JB3	Backlight on/off polarity control	1-2 H = On, 2-3 L = On

**Brightness:** There are various methods for brightness control and it is important to consider the specifications for the backlight driver to be used. Generally the situation is:

- Brightness can controlled by using a resistor or VR (Variable Resistor).
- Brightness controlled by adding a circuit such as PWM (Pulse Width Modulation).
- No adjustment of brightness is possible.

CNB1 pins 4 & 5 are available for connecting to an backlight driver or circuit where VR control is supported.

#### CNB1

PIN	DESCRIPTION
4	VR WIP
5	VR A

This can then be matched with function controls (OSD switch mount) pins 3 & 4: see cable design below .

**Design Guideline for making VR circuitry :**

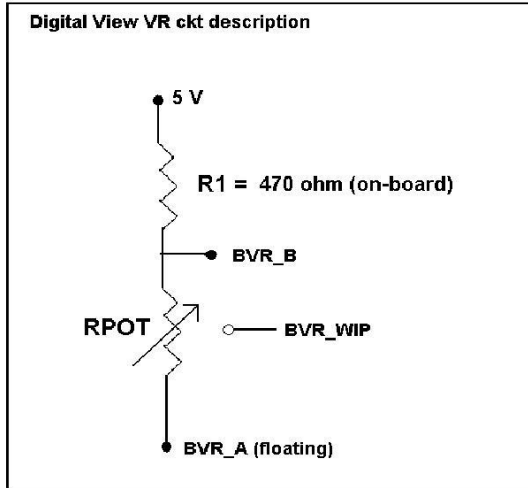

**Signal description / Notes :**

- 1) R1 : 470ohm on board
- 2) RPOT is an external potentiometer (in-line dip style) that can be plugged directly into CNC1 pins 3,4,5. RPOT must be supplied / installed by user.
- 3) BVR\_B : Voltage tapped from “top” of potentiometer, the node of R1 and RPOT.
- 4) BVR\_WIP : Voltage tapped from wiper arm of RPOT.
- 5) BVR\_A : Voltage tapped from “bottom” of RPOT.

**Note : BVR\_A voltage is left floating on the controller board. To use this circuit, you need to tie this point to a potential (usually GND, available at CNC1 pin 6).**

**CNB1 – Backlight control connector: JST B5B-XH-A (Matching type : XHP-5)**

PIN	SYMBOL	DESCRIPTION
1	GND	Ground
2	VBKL	+12VDC / 24VDC, backlight power supply (selected by JA3 & JA6)
3	BLCTRL	On/Off control (enable) – see JB2 & JB3
4	BVR_WIP	Brightness VR - WIP
5	BVR_A	Brightness VR A

**CNC1 – Control switch, JST B12B-XH-A (Matching type : XHP-12)**

PIN	SYMBOL	DESCRIPTION
1	PSWIN	Power button A
2	SW_ON	Power button B
3	BVR_A	Backlight Brightness VR pin A
4	BVR_WIP	Backlight Brightness R pin WIP
5	BVR_B	Backlight Brightness VR pin B (470 ohm resistor to +5V Vcc)
6	GND	Ground
7	MENU	OSD menu
8	-/LEFT	OSD -/Left
9	+ /RIGHT	OSD +/Right
10	SEL_DN	OSD Select down
11	SEL_UP	OSD Select up
12	NC	No connection

The VR for brightness depends on the backlight driver. The main power load for On/Off is handled by a relay on the ontroller.

**Example for circuit design :**

- 1.) Choose RPOT = 10K
- 2.) Tie BVR\_A to GND
- 3.) Circuit analysis gives BVR\_WIP as the following (see Figure 1)

$$BVR\_WIP = 5 \times (Rbc/10.47)$$

where BVR\_WIP is in Volts.  
And Rbc is the resistance from the wiper arm to bottom of pot in Kohms.

To evaluate, plug in different values of Rbc :

Rbc	BVR_WIP
0	0 V
2.5 K	1.2 V
5 K	2.4 V
7.5 K	3.6 V
10 K	4.8 V

So this circuit could provide Brightness adjust voltage ranging from 0V to 5V.

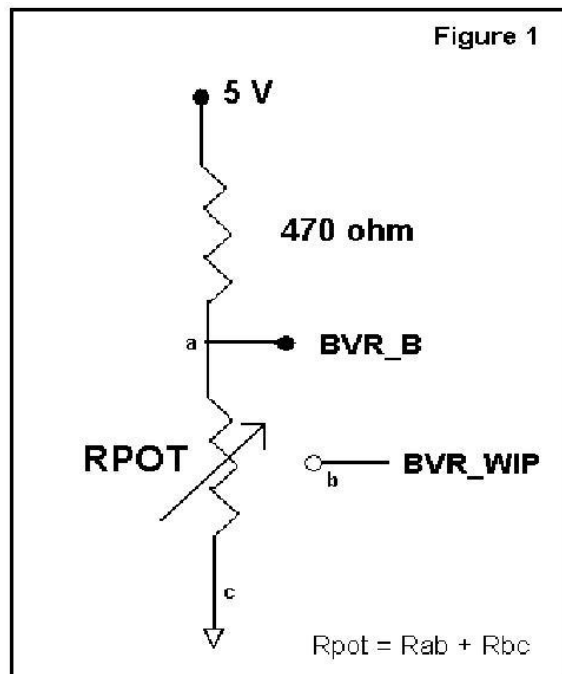

Specifications subject to change without notice

---

## TROUBLESHOOTING

### General

A general guide to troubleshooting a flat panel display system it is worth considering the system as separate elements, such as:

- Controller (jumpers, PC settings)
- Panel (controller, cabling, connection, panel, PC settings)
- Backlight (backlight driver, cabling, backlight tubes)
- Cabling
- Computer system (display settings, operating system)

Through step by step cross checking with instruction manuals and a process of elimination to isolate the problem it is usually possible to clearly identify the problem area.

### No image:

- If the panel backlight is not working it may still be possible to just see some image on the display.
- A lack of image is most likely to be caused by incorrect connection, lack of power, failure to provide a signal or incorrect graphic card settings.

### Image position:

If it is impossible to position the image correctly, ie the image adjustment controls will not move the image far enough, then test using another graphics card. This situation can occur with a custom graphics card that is not close to standard timings or if something is in the graphics line that may be affecting the signal such as a signal splitter (please note that normally a signal splitter will not have any adverse effect).

### Image appearance:

- A faulty panel can have blank lines, failed sections, flickering or flashing display
- Incorrect graphics card refresh rate, resolution or interlaced mode will probably cause the image to be the wrong size, to scroll, flicker badly or possibly even no image.
- Incorrect jumper settings on the controller may cause everything from total failure to incorrect image. CAUTION: Do not set the panel power input incorrectly.
- Sparkling on the display: faulty panel signal cable.

### Backlight:

Items to check include: Power input, Controls, backlight drivers and Tubes generally in this order.

If half the screen is dimmer than the other half:

- Check cabling for the backlight driver.
- For a specific backlight tube check the AC pins orientation (CAUTION: Never reverse any DC power pins).

Also:

- If adjusting brightness control has no effect the chances are that the VR rating or method of adjusting brightness is not compatible or correctly connected to the backlight driver.
- If system does not power down when there is a loss of signal

### Continued failure:

If unit after unit keeps failing consider and investigate whether you are short circuiting the equipment or doing something else seriously wrong.

Generally after common sense issues have been resolved we recommend step by step substitution of known working parts to isolate the problem.

## SPECIFICATIONS

Panel compatibility	1440x900, 1366x768, 1280x1024, 1280x800, 1024x768, 800x600, 640x480 resolution TFT LVDS or TTL LCD's support.
No. of colours	Up to 3 x 8 bit providing 16.7 million colours.
Vertical refresh rate	SXGA, XGA, SVGA, VGA resolution up to 60Hz.
Dot clock (pixel clock) maximum	135 MHz
Graphics formats	Up to 1440x900 (refer to Appendix I)
Standard input at source	- VGA analog (15-pin) standard with automatic detection of : Digital Separate Sync Sync On Green - DVI-D
Controls available	- On/Off - Brightness (backlight) - OSD menu - OSD select - OSD setting + - OSD setting -
Control interface	- Buttons
Settings memory	Settings are stored in non volatile memory
Language OSD support	Yes
Graphics OSD icons	Yes
VESA DPMS implementation	Yes
Plug & Play	VESA DDC 1, 2/b compatible
Voltage output for LCD	+3.3V , +5V, +12V, +18V The current drawn for 18V panel from 24VDC power input is limited to 2A. The current drawn for 3.3V, 5V or 12V panel from 12V/24VDC power input is limited to 3A.
Input voltage	12VDC , 5A max / 24VDC 5A max +/- 5%
Controller power consumption	Approx 2.5W(controller logic only, no panel and backlight driver are involved)
Controller dimensions	107.4mm x 91.4mm x 17.1mm
Storage temperature limits	-40°C to +70°C
Operating temperature limits	0°C to +60°C

### NOTES

Please note the following:

- For specific panel setup a sample of an LCD may be required (this will be returned) and a copy of the full technical specifications for the panel from the manufacturer.
- Layout and custom development services are available.

## Appendix I – Mode Support Table

### VGA port :

Resolution	Sync Mode
640x480 60Hz	Digital Separate Sync
800x600 56Hz	Digital Separate Sync
800x600 56Hz	Sync On Green
800x600 60Hz	Digital Separate Sync
800x600 60Hz	Sync On Green
1024x768 60Hz	Digital Separate Sync
1024x768 60Hz	Sync On Green
1280x768 60Hz	Digital Separate Sync
1280x768 60Hz	Sync On Green
1280x800 60Hz	Digital Separate Sync
1280x800 60Hz	Sync On Green
1280x1024 60Hz	Digital Separate Sync
1280x1024 60Hz	Sync On Green
1360x768 60Hz	Digital Separate Sync
1360x768 60Hz	Sync On Green
1366x768 60Hz	Digital Separate Sync
1366x768 60Hz	Sync On Green
1440x900 60Hz	Digital Separate Sync
1440x900 60Hz	Sync On Green



**DVI port :**

<b>Resolution</b>
640x480 60Hz
800x600 56Hz
800x600 60Hz
1024x768 60Hz
1280x768 60Hz
1280x800 60Hz
1280x1024 60Hz
1360x768 60Hz
1366x768 60Hz
1440x900 60Hz

**Remark :**

The controller has been designed to take a very wide range of input signals however to optimize the PC's graphics performance we recommend choosing 60Hz vertical refresh rate. To support on higher refresh rate over 60Hz, the LCD panel may not support.

## Appendix II – RS-232 control protocols

### RS-232 Serial control (Baud rate 2400, 8 bits, 1 stop bit and no parity)

Physical connection :

Controller side  
Connector interface : CN8  
Mating connector : JST XHP-6

Computer side  
Connector interface : Serial port  
Mating connector : DB9 Female

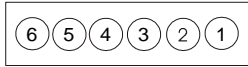

Mating face of CN8

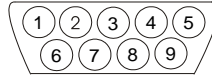

Mating face of RS-232 DB9 Male

PIN#	Description
4	RS-232 Tx Data
5	Ground
6	RS-232 Rx Data

PIN#	Description
2	RS-232 Rx Data
3	RS-232 Tx Data
5	Ground

Remark :

(1) : RS-232 connection cable, 600mm P/N 426090200-3 can be ordered separately for connection.

Software connection :

The OSD function can be controlled through sending the RS-232 protocol.

The RS-232 program can be custom-made to fit for application or it can be used the program provided by Digitalview on request. Please contact your local sales for informations.

#### 1. Commands to implement switch mount control buttons

Function	Command	Description	Acknowledge (if enabled)
Menu	0xf7	Menu button pressed	Button equivalent
Select-down button	0xfa	Select down button pressed	Button equivalent
Select-up button	0xfb	Select up button pressed	Button equivalent
Right/+ button	0xfc	Right/+button pressed	Button equivalent
Left/- button	0xfd	Left/- button pressed	Button equivalent

#### 2. Parameter setting - immediate, relative, reset and query

Function	Command	Description	Acknowledge (if enabled)
Brightness control	0x81, nn   "+"   "-"   "r"   "R"   "?"	Set brightness = value/increment/decrement Reset Query	Brightness.  Range: "0"0"-F"0 Default: "8"0
Contrast control	0x82, "a"   "A", nn   "+"   "-"   "r"   "R"   "?"	Set all contrast = value/increment/decrement Reset Query	Contrast.  Range: "0"0"-F"0 Default: "8"0
Phase #	0x85, nn   "+"   "-"   "?"	Set dot clock phase = value/increment/decrement Query	Dot clock phase. (In VGA mode only)
Image H position #	0x86, nn   "+"   "-"   "?"	Set img_hpos = value/increment/decrement Query	Image horizontal position. (In VGA mode only)
Image V position #	0x87, nn   "+"   "-"   "?"	Set img_vpos = value/increment/decrement Query	Image vertical position. (In VGA mode only)

Sharpness	0x8a, n   "+"   "-"   "r"   "R"   "?"	Set sharpness = value/increment/decrement Reset Query	Sharpness. "0x30" – 0 (Default) "0x31" – 1 "0x32" – 2 "0x33" – 3 "0x34" – 4 "0x35" – 5 "0x36" – 6
Clock #	0x8b, nn   "+"   "-"   "?"	Set H active size = value/increment/decrement Query	Frequency adjustment (In VGA mode only)
Scaling Mode	0x8c, n   "r"   "R"   "?"	Set graphic image scaling mode = value Reset Query	Image expansion on/off. "0x31" – Wide (Fill Screen) "0x39" – 4:3
OSD H position	0x90, nnn   "+"   "-"   "r"   "R"   "?"	Set osd_hpos = value/increment/decrement Reset Query	OSD horizontal position  Range: "0"0"0"0"-"0"6"4" Default: "0"3"2"
OSD V position	0x91, nnn   "+"   "-"   "r"   "R"   "?"	Set osd_vpos = value/increment/decrement Reset Query	OSD vertical position  Range: "0"0"0"0"-"0"6"4" Default: "0"3"2"
OSD Transparency	0x92, n "r"   "R"   "?"	Set OSD transparency = value/increment/decrement Reset Query	OSD transparency.  "0x30" – 0 (Default) "0x31" – 25 "0x32" – 50 "0x33" – 75 "0x34" – 100
OSD menu timeout	0x93, nn   "+"   "-"   "r"   "R"   "?"	Select menu timeout = value/increment/decrement Reset Query	OSD menu timeout value. If value > max available step, set it to the max available step. "0x30,0x30" – 0 (Always on) "0x30,0x41" – 10 sec (Default) "0x31,0x34" – 20 sec "0x31,0x45" – 30 sec "0x32,0x38" – 40 sec "0x33,0x32" – 50 sec "0x33,0x43" – 60 sec
Select OSD language	0x95, n   "r"   "R"   "?"	Select language = English, French,... Reset Query	"0x30" – English (Default) "0x32" - French "0x33" – Spanish
Input main select  * Function in valid mode only	0x98, nn   "+"   "-"   "r"   "R"   "?"	Select input main = PC or video or next available Reset Query	Main selected. "0x41,0x31" VGA (Default) "0x46,0x31" DVI
Auto Source Seek	0x99, "0"   "1"   "?"	Disable/ Enable Query	"0x30" – Disable "0x31" – Enable (Default)
GAMMA value select	0x9d, n   "r"   "R" "?"	Select GAMMA value = Value Reset Query	GAMMA value: "0x30" – 0.4, "0x31" – 0.6 "0x32" – 1.0 (Default), "0x33" – 1.6 "0x34" – 2.2
Colour temperature select	0xb3, n	Select colour temperature = value	Main selected. "0" – user defined RGB values.

Specifications subject to change without notice

	"r"   "R"   "?"	Reset Query	"1" – 4200K. "2" – 5000K. "3" – 6500K. "4" – 7500K. (Default) "5" – 9300K.
Red level for selected colour temperature	0xb4, nn   "+"   "-"   "r"   "R"   "?"	Set the level of the red channel for the selected colour temp. = value/increment/decrement Reset Query	Red level for selected colour temperature.  Range: "0"0"- "F" "F" Default: "8" "0"
Green level for selected colour temperature	0xb5, nn   "+"   "-"   "r"   "R"   "?"	Set the level of the green channel for the selected colour temp. = value/increment/decrement Reset Query	Green level for selected colour temperature.  Range: "0" "0"- "F" "F" Default: "8" "0"
Blue level for selected colour temperature	0xb6, nn   "+"   "-"   "r"   "R"   "?"	Set the level of the blue channel for the selected colour temp. = value/increment/decrement Reset Query	Blue level for selected colour temperature.  Range: "0" "0"- "F" "F" Default: "8" "0"
OSD turn off	0xbd	Turn off the OSD	"1" - successful
Wide Screen Mode Selection	0xd9, "0"   "1"   "2"   "3" "r"   "R" "?"	Wide Screen Mode Reset Query	"0" – 1280x768 "1" – 1360x768 "2" – 1366x768 "3" – 1368x768

Backlight brightness control	0xe0, nn   "+"   "-"   "r"   "R"   "?"	Set backlight brightness = value/increment/decrement Reset Query	Backlight brightness.  Range: D/A : "0" "0" - "6" "4" 100Hz : "0" "0" ~ "6" "4" 120Hz : "0" "0" ~ "6" "4" 140Hz : "0" "0" ~ "6" "4" 160Hz : "0" "0" ~ "6" "4" 180Hz : "0" "0" ~ "6" "4" 200Hz : "0" "0" ~ "6" "4" 220Hz : "0" "0" ~ "6" "4" 240Hz : "0" "0" ~ "6" "4" 260Hz : "0" "0" ~ "6" "4" 280Hz : "0" "0" ~ "6" "4" 300Hz : "0" "0" ~ "6" "4" 320Hz : "0" "0" ~ "6" "4" 340Hz : "0" "0" ~ "6" "4" 360Hz : "0" "0" ~ "6" "4" 380Hz : "0" "0" ~ "6" "4" 400Hz : "0" "0" ~ "6" "4" 420Hz : "0" "0" ~ "6" "4" 440Hz : "0" "0" ~ "6" "4"
Backlight on/off control	0xe1, "0"   "1"   "r"   "R"   "?"	Set backlight brightness = Disable backlight Enable backlight Reset Query Backlight working status	Backlight on/off.  "1" = normal (Default)
Backlight D/A or PWM selection	0xe5, "0"   "1"   "?"	Set: PWM or D/A Query	"1" – PWM "0" – D/A
Backlight PWM Frequency	0xe6, nnn   "+"   "-"   "?"	Set Backlight PWM Frequency = Value/ increment/ decrement Query	+/- 20Hz Value 100Hz : "0", "6", "4" 120Hz : "0", "7", "8" 140Hz : "0", "8", "C" 160Hz : "0", "A", "0" 180Hz : "0", "B", "4" 200Hz : "0", "C", "8" 220Hz : "0", "D", "C" 240Hz : "0", "F", "0" 260Hz : "1", "0", "4" 280Hz : "1", "1", "8" 300Hz : "1", "2", "C" 320Hz : "1", "4", "0" 340Hz : "1", "5", "4" 360Hz : "1", "6", "8" 380Hz : "1", "7", "C" 400Hz : "1", "9", "0" 420Hz : "1", "A", "4" 440Hz : "1", "B", "8"
Backlight Invert	0xe7, 0   "1"   "?"	Set On or Off Query	"1" – Invert "0" – Normal

# - Function in VGA mode only

### 3. Other control

Function	Command	Description	Acknowledge (if enabled)
Select RS-232 acknowledge	0xc1, "0"   "1"	Disable/enable command acknowledge.	"0" – acknowledge disabled. "1" – acknowledge enabled.
Image Auto Adjust <sup>#</sup>	0xc3	Start auto-setup of current mode.	"0" – fail. "1" – successful.
Command availability	0xc4, n	Check whether a command is available.	"0" – not available. "1" – available.
Color Auto Adjust <sup>#</sup>	0xc5	Start auto-calibration of gain of the RGB amplifier.	"0" – fail. "1" – successful.
Query video input status	0xc9	Query the status of the primary & pip status	"nn,nn" = input status "nn,xx" digit = primary status: "0", "0" : invalid "A", "1" VGA "F", "1" DVI  "xx,nn" = PIP input status: "0", "0": invalid
Query BIOS version	0xcb, "0"	Read BIOS version	"nnnn" = BIOS ver. "nn.nn"
Query PCBA number	0xcb, "1"	Read PCBA number	"nnnn" = PCBA number ALR-1400v2="41758"
Factory Reset	0xce	Reset all parameters to factory default value	"1" – successful.
Soft Power On/Off	0xc8, "0"   "1"   "?"	Soft power off/on query	"0" – Turn off the LCD panel power output "1" – Turn on the unit

# - Function in VGA mode only

#### Hex to ASCII conversion table

Hex	ASCII	Hex	ASCII	Hex	ASCII	Hex	ASCII
0x30	0	0x41	A	0x61	a	0x2B	+
0x31	1	0x42	B	0x62	b	0x2D	-
0x32	2	0x43	C	0x63	c	0x3F	?
0x33	3	0x44	D	0x64	d		
0x34	4	0x45	E	0x65	e		
0x35	5	0x46	F	0x66	f		
0x36	6	0x47	G	0x67	g		
0x37	7	0x48	H	0x68	h		
0x38	8	0x49	I	0x69	i		
0x39	9	0x4A	J	0x6A	j		
		0x4B	K	0x6B	k		
		0x4C	L	0x6C	l		
		0x4D	M	0x6D	m		
		0x4E	N	0x6E	n		
		0x4F	O	0x6F	o		
		0x50	P	0x70	p		
		0x51	Q	0x71	q		
		0x52	R	0x72	r		
		0x53	S	0x73	s		
		0x54	T	0x74	t		
		0x55	U	0x75	u		
		0x56	V	0x76	v		
		0x57	W	0x77	w		
		0x58	X	0x78	x		
		0x59	Y	0x79	y		
		0x5A	Z	0x7A	z		

## Appendix III – Mapping definition

- Definition of Mapping A :

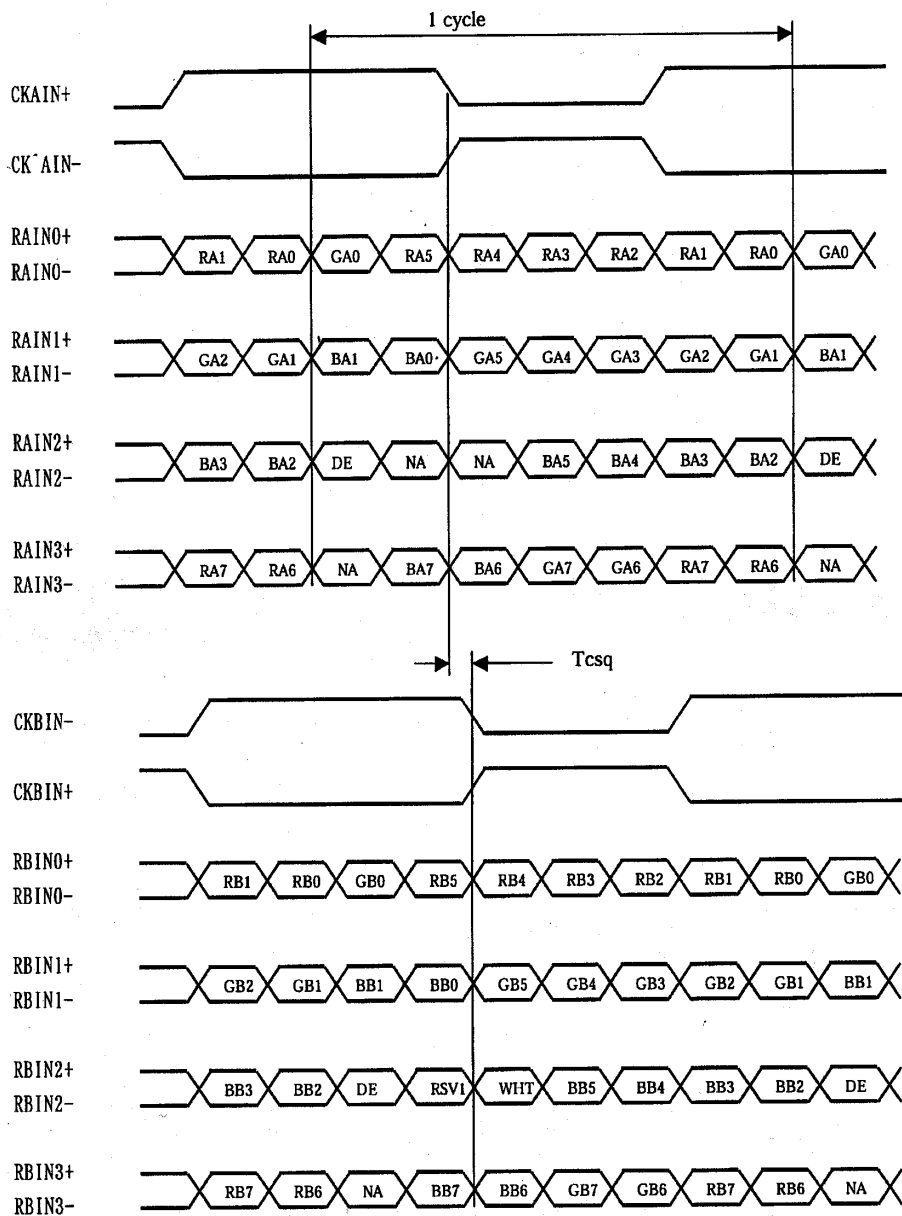

- Definition of Mapping B :

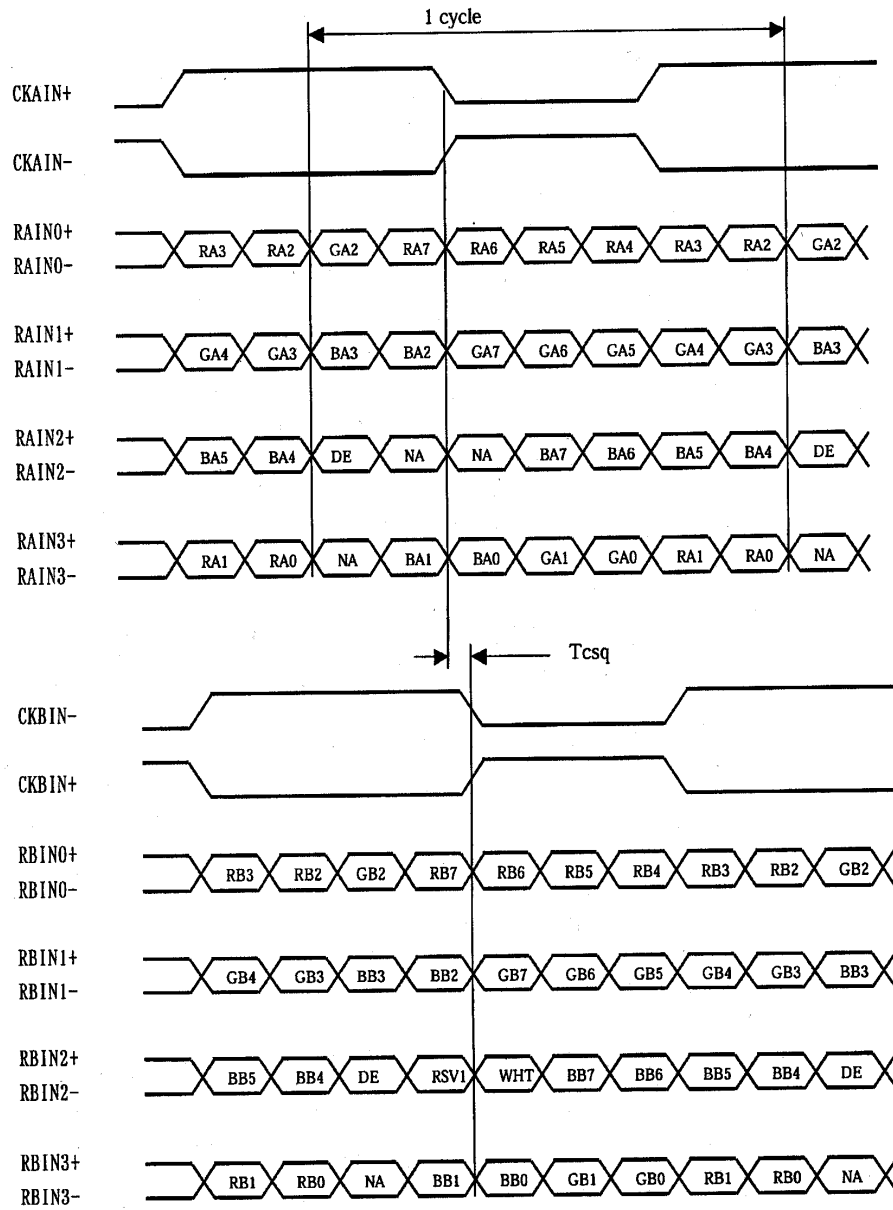



---

## Appendix IV – Color Auto Adjust

The Color Auto Adjust function is supported in the VGA mode only and is designed to calibrate the controller to the incoming video signal. In order to calibrate correctly, the display must be displaying an image containing both black and white data (see illustration below) when the function is used. The internal processor of the video controller chip will then execute a process to adjust the relative values of the RGB signals to achieve the best performance. The parameters of the corrected RGB values are then stored in the controller and are unaffected by the Reset Factory Defaults function.

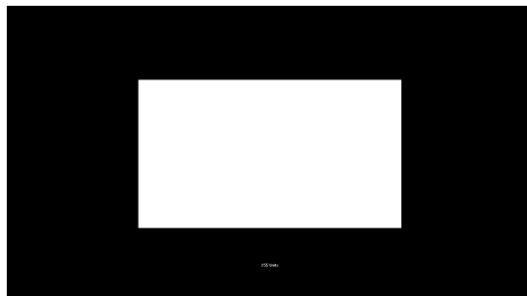

**Warning** - If the Color Auto Adjust is executed without an appropriate image being displayed, then the process will set incorrect values and the display colors will be distorted. If this occurs, then it can either be corrected by performing the process correctly or if this is not possible then the Reset Color Gain function can be used. This function will reset the stored RGB values to a set of approximate values.

---

## WARRANTY

The products are warranted against defects in workmanship and material for a period of three (3) year from the date of purchase provided no modifications are made to it and it is operated under normal conditions and in compliance with the instruction manual.

The warranty does not apply to:

- Product that has been installed incorrectly, this specifically includes but is not limited to cases where electrical short circuit is caused.
- Product that has been altered or repaired except by the manufacturer (or with the manufacturer's consent).
- Product that has subjected to misuse, accidents, abuse, negligence or unusual stress whether physical or electrical.
- Ordinary wear and tear.

Except for the above express warranties, the manufacturer disclaims all warranties on products furnished hereunder, including all implied warranties of merchantability and fitness for a particular application or purpose. The stated express warranties are in lieu of all obligations or liabilities on the part of the manufacturer for damages, including but not limited to special, indirect consequential damages arising out of or in connection with the use of or performance of the products.

---

## CAUTION

Whilst care has been taken to provide as much detail as possible for use of this product it cannot be relied upon as an exhaustive source of information. This product is for use by suitably qualified persons who understand the nature of the work they are doing and are able to take suitable precautions and design and produce a product that is safe and meets regulatory requirements.

---

## LIMITATION OF LIABILITY

The manufacturer's liability for damages to customer or others resulting from the use of any product supplied hereunder shall in no event exceed the purchase price of said product.

---

## TRADEMARKS

The following are trademarks of Digital View Ltd:

- Digital View
- ALR-1400v2

---

## CONTACT DETAILS

Digital View has offices in Asia, Europe and USA also an internet site:

### ASIA

Digital View Ltd  
2<sup>nd</sup> Floor Bamboos Center  
52 Hung To Road  
Kwun Tong  
Hong Kong

**Tel:** (852) 2861 3615

**Fax:** (852) 2520 2987

**Sales:** [hksales@digitalview.com](mailto:hksales@digitalview.com)

### EUROPE

Digital View Ltd.  
6 Marylebone Passage,  
London, W1W 8EX  
UK

**Tel:** +44-(0)20-7631-2150

**Fax:** +44-(0)20-7631-2156

**Sales:** [uksales@digitalview.com](mailto:uksales@digitalview.com)

### USA

Digital View Inc.  
18440 Technology Drive  
Building 130  
Morgan Hill,  
California, 95037  
USA

**Tel:** (1) 408-782 7773

**Fax:** (1) 408-782 7883

**Sales:** [ussales@digitalview.com](mailto:ussales@digitalview.com)

### WEBSITE

[www.digitalview.com](http://www.digitalview.com)